

Item # 54

SEMINOLE COUNTY GOVERNMENT
AGENDA MEMORANDUM

(Continued From March 11, 2003)

SUBJECT: Comprehensive Plan Amendment from Suburban Estates to Planned Development and rezoning from A-1 (Agriculture) to PUD (Planned Unit Development), Carmen and Fred Edwards, owners; James H. Fant, applicant

DEPARTMENT: Planning & Development **DIVISION:** Planning

AUTHORIZED BY: Donald S. Fisher **CONTACT:** Kent A. Cichon **EXT.** 7126

Agenda Date <u>04/8/02</u>	Regular <input type="checkbox"/>	Consent <input type="checkbox"/>	Work Session <input type="checkbox"/>	Briefing <input type="checkbox"/>
	Public Hearing – 1:30 <input type="checkbox"/>		Public Hearing – 7:00 <input checked="" type="checkbox"/>	

MOTION/RECOMMENDATION:

1. Transmit the comprehensive plan amendment from Suburban Estates to Planned Development and rezoning from A-1 (Agriculture) to PUD (Planned Unit Development) for 25.05 acres located on the west side of Banana Lake Road, approximately 3,400 feet south of CR 46A to the Department of Community Affairs, per the attached development order, but do not adopt until the applicant has demonstrated the existence of sufficient ROW to improve the length of Banana Lake Road to County standards, James H. Fant, applicant; or
2. Deny a comprehensive plan amendment from Suburban Estates to Planned Development and rezoning from A-1 (Agriculture) to PUD (Planned Unit Development) for 25.05 acres located on the west side of Banana Lake Road, approximately 3400 feet south of CR 46A, James H. Fant, applicant; or
3. Continue until a date and time certain.

District 5, Commissioner McLain

Kent A. Cichon, Financial Manager

BACKGROUND:

This item was scheduled for the March 11, 2003, Board of County Commissioners public hearing. The applicant requested continuance of this item until April 8, 2003, to modify the proposed plan and address access issues with neighboring property owners. The Board of County Commissioners continued the item as requested.

Reviewed by:	<u>AKO</u>
Co Atty:	<u>AKO</u>
DFS:	<u>AKO</u>
Other:	<u>AKO</u>
DCM:	<u>AKO</u>
CM:	<u>AKO</u>
File No.	<u>ph700pdp08</u>

The applicant is requesting to amend the future land use designation from Suburban Estates to Planned Development and to rezone 25.05 acres from A-1 (Agriculture) to PUD (Planned Unit Development), proposing 43 dwelling units at a net density of 5.7 units per acre for property located on the west side of Banana Lake Road approximately 3400' south of CR 46A.

Previously, a request was submitted for a large scale land use amendment from Suburban Estates to Planned Development and associated rezoning from A-1 (Agriculture) to PUD (Planned Unit Development), with a proposal of a development of townhomes consisting of 82 dwelling units at a net density of approximately 9.9 units per acre. At their February 6, 2002, public hearing, the Land Planning Agency/Planning & Zoning Commission unanimously recommended denial of this request. At the March 26, 2002, public hearing, the BCC unanimously voted to continue the proposed land use amendment and rezoning until the Fall 2002 Large Scale Land Use Amendment Cycle.

This item was then continued from the March 26, 2002, Board of County Commissioners meeting at the request of the property owner's representative. The applicant requested continuance of this item until the Spring 2003 Large Scale Land Use Amendment Cycle in order to resolve a number of development issues.

This proposal has subsequently been revised to a development of single family homes consisting of 43 dwelling units at a net density of 6.05 units per acre, and was scheduled for the January 8, 2003, Planning Agency/Planning & Zoning Commission meeting; however, it was continued at the request of the applicant. The applicant requested a continuance until February 19, 2003, in order for the applicant to demonstrate his plan and intent to modify Banana Lake Road to county standards or to seek access south through Heathrow International Business Center. Consequently, if there exists adequate right-of-way, the applicant is seeking the prior and has generally demonstrated to staff his plan and intent to modify Banana Lake Road to county standards. Staff will review all final detailed improvements to the road at the final engineering stage of the approval process.

Should the applicant not demonstrate the existence of sufficient right-of-way to improve the length of Banana Lake Road to County standards, prior to the second scheduled public hearing for this item, staff will recommend denial of adoption of the comprehensive plan amendment from Suburban Estates to Planned Development and rezoning from A-1 (Agriculture) to PUD (Planned Unit Development).

Further, with regard to surrounding properties, in 1998 the Board of County Commissioners approved a large scale land use amendment from Suburban Estates to Planned Development, and associated rezoning from A-1 to PUD for the property to the south. When completed, the project will consist of 252 apartment units in two-story buildings on 28.5 acres. The plan amendment was found in compliance by the Department of Community Affairs (DCA), but Mr. Edwards, the property owner, subsequently initiated administrative proceedings which resulted in a compliance agreement between Colonial Realty (applicant), Mr. Edwards, the DCA, and the County. (Please see Exhibits A and B, attached) The Agreement restricted the development rights on a 200 foot strip of land between the Edwards' and Colonial Realty's properties.

STAFF RECOMMENDATION:

Planning staff recommends transmittal of this request with staff findings subject to the attached Development Order, but does not recommend adoption until the applicant has demonstrated the existence of sufficient ROW to improve the length of Banana Lake Road to County standards.

LP/P&Z RECOMMENDATION:

At its meeting of February 19, 2003, the Planning and Zoning Commission recommended denial.

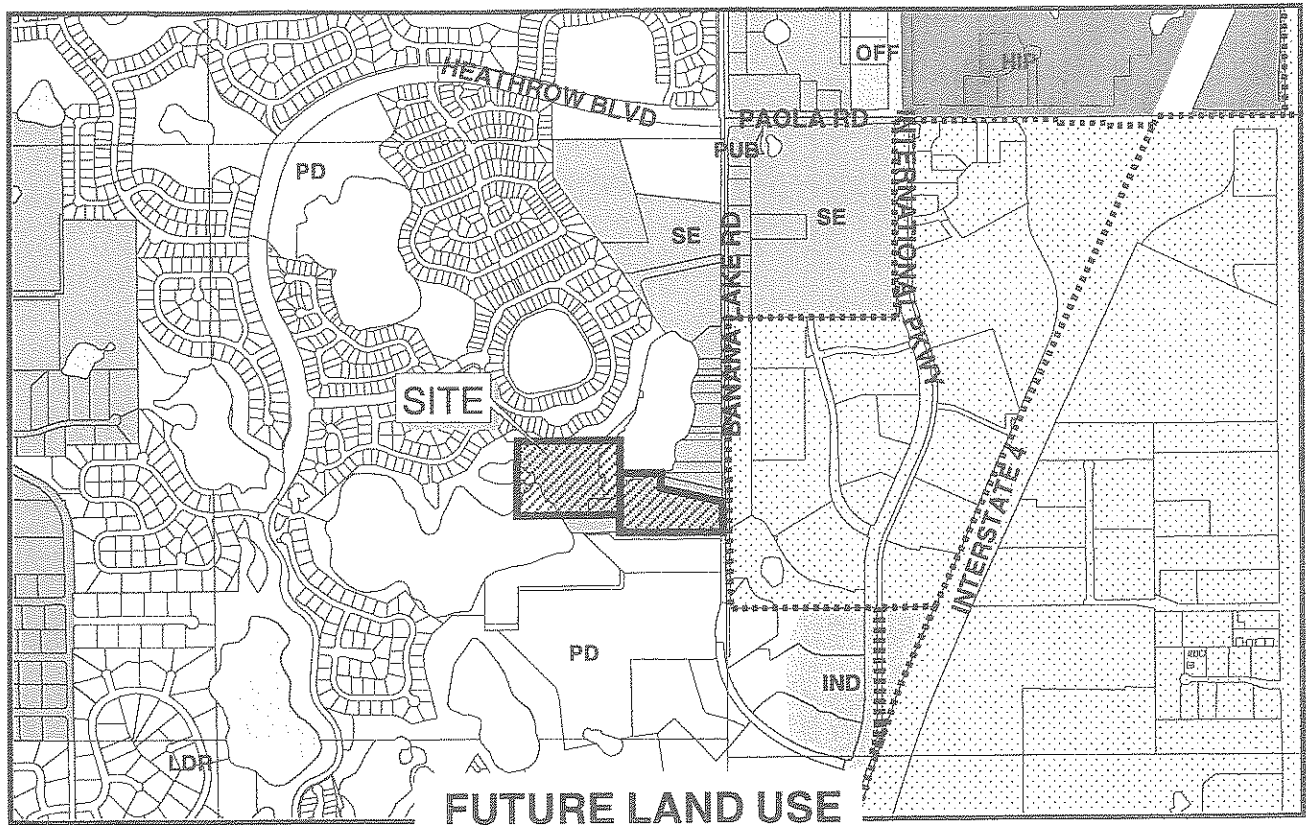

FUTURE LAND USE

Site
 Municipality
 LDR
 PUB
 PD
 SE
 HIP
 OFF
 IND

Applicant: James H. Fant
 Physical STR: 01-20-29-300-0040, 0050 & 0080-0000
 Gross Acres: +/- 25.05 BCC District: 5
 Existing Use: Vacant
 Special Notes: _____

	Amend/ Rezone#	From	To
FLU	02S.FLU04	SE	PD
Zoning	Z2001-044	A-1	PUD

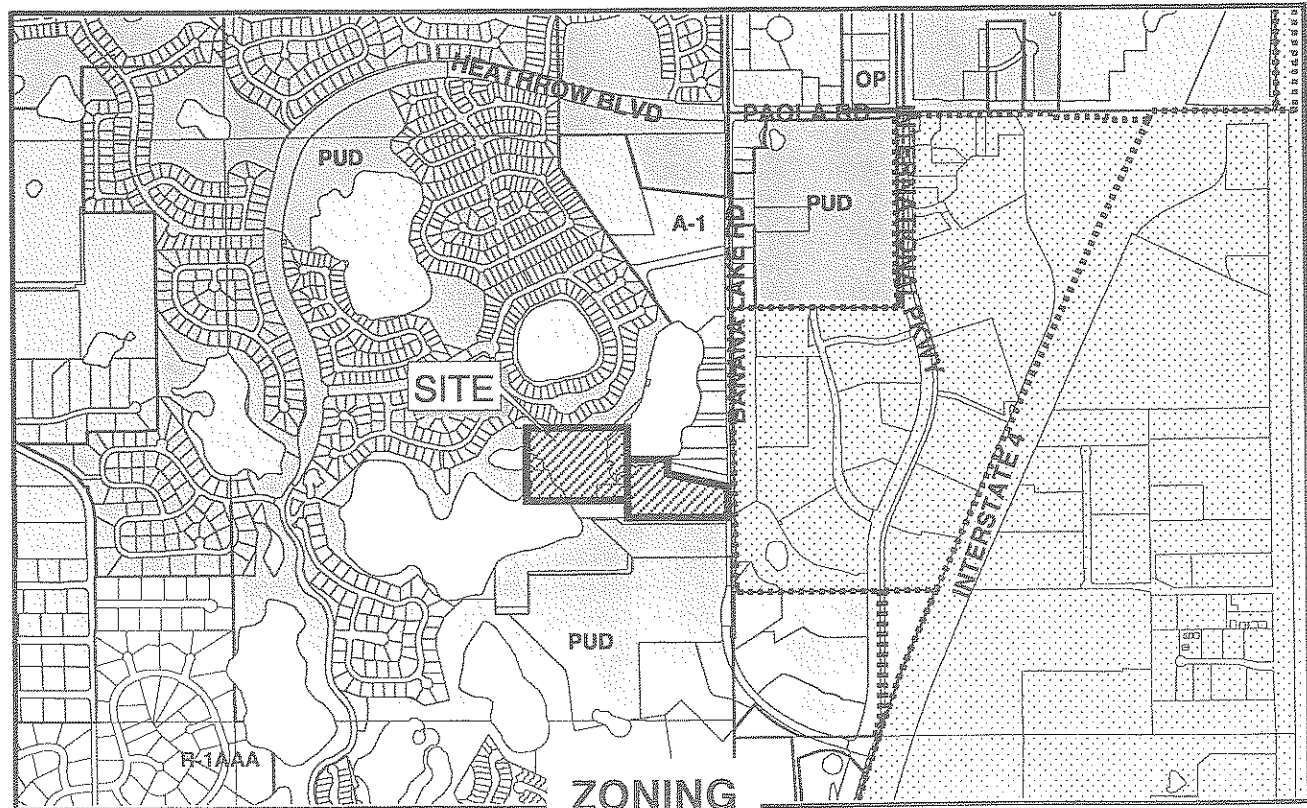

ZONING

A-1
 PUD
 R-1AAA
 OP





Amendment No. 02S.FLU04

From: SE To: PD

Rezone No. Z2001-044

From: A-1 To: PUD

 Subject Property

 Parcelbase



February 1999 Color Aerials

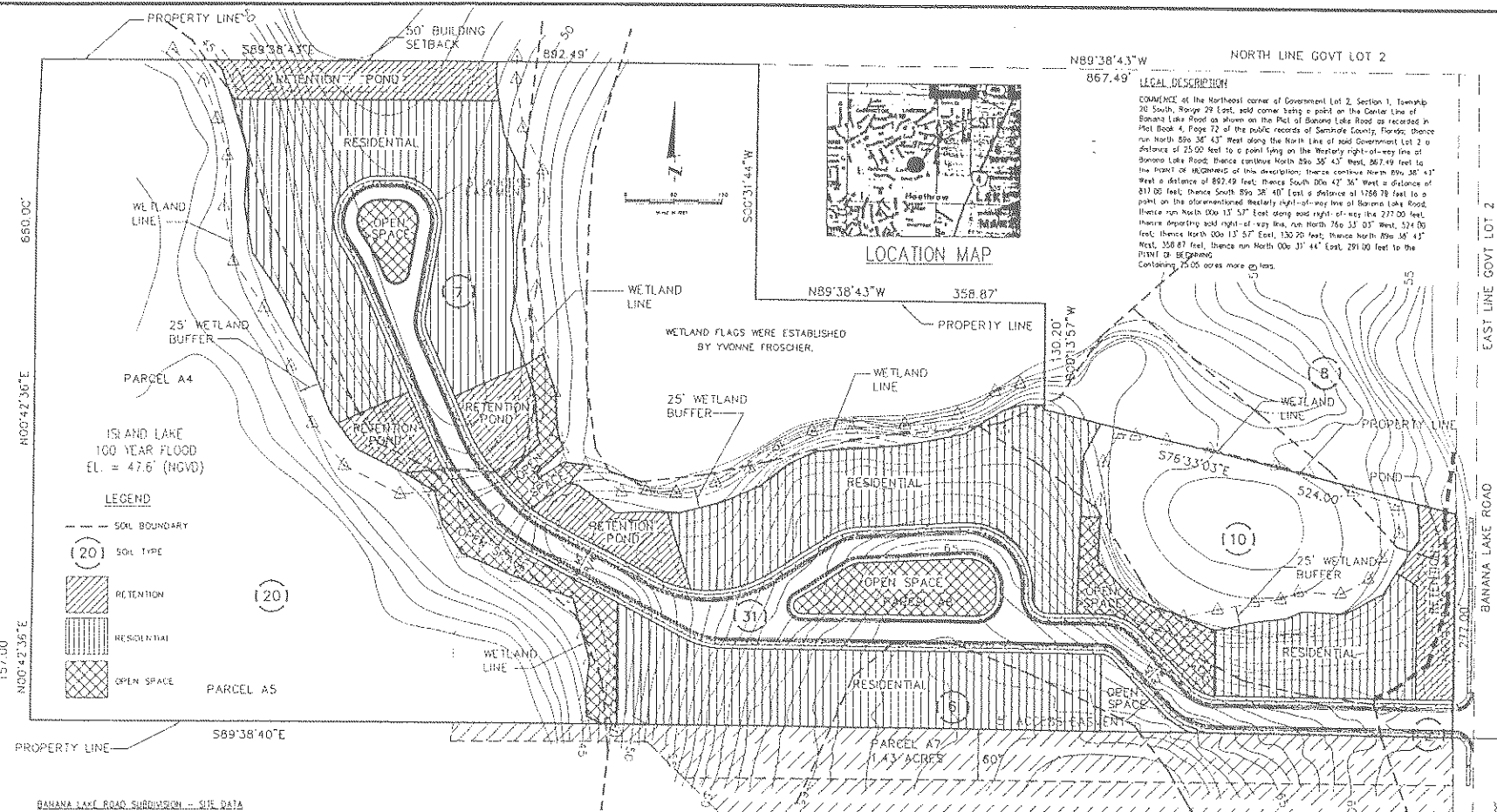

N89°38'43"W
867.49'

NORTH LINE GOVT LOT 2

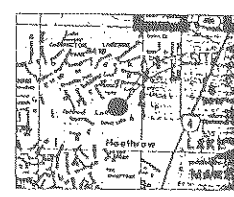

LOCATION MAP

LEGAL DESCRIPTION
 COMMENCE at the Northwest corner of Government Lot 2, Section 1, Township 26 South, Range 28 East, and come thence a point on the Center Line of Banana Lake Road as shown on the Plat of Banana Lake Road as recited in Plat Book 4, Page 72 of the public records of Seminole County, Florida; thence run North 89° 38' 43" West along the North Line of said Government Lot 2 a distance of 25.00 feet to a point on the Westery right-of-way line of Banana Lake Road; thence continue North 25° 35' 43" West, 867.49 feet to the POINT OF BEGINNING of this development; thence continue North 25° 35' 43" West a distance of 823.19 feet; thence South 25° 42' 30" West a distance of 811.00 feet; thence South 89° 28' 40" East a distance of 1268.78 feet to a point on the aforementioned Westery right-of-way line of Banana Lake Road; thence run North 25° 35' 43" West along said right-of-way line 184.27 feet; thence departing said right-of-way line, run North 75° 55' 05" West, 574.00 feet; thence North 55° 15' 57" East, 132.00 feet; thence North 35° 45' West, 358.87 feet; thence run North 00° 31' 44" East, 291.00 feet to the POINT OF BEGINNING containing 79.00 acres more or less.

680.00'
 157.00'
 100°42'36"E
 100°42'36"E

ISLAND LAKE
 100 YEAR FLOOD
 EL. = 47.6' (MGVD)

LEGEND

- SOIL BOUNDARY
- (20) SOIL TYPE
- [Hatched] RETENTION
- [Hatched] RESIDENTIAL
- [Cross-hatched] OPEN SPACE

BANANA LAKE ROAD SUBDIVISION - SITE DATA

1. PROJECT AREA DATA:
 PARCEL # ACRES
 A4 20.29 300-0000-0000
 A5 20.29 300-0000-0000
 A7 20.29 300-0000-0000
 TOTAL APPLICANT-OWNED AREA = 35.00 ACRES
 TOTAL DEVELOPABLE AREA = 7.11 ACRES
2. EXISTING CONDITIONS INFORMATION:
 ZONING = A-1 (FLORIDA RURAL)
 LAND-USE DESIGNATION = SUBURBAN ESTATES
 UTILITIES = FLORIDA POWER CORP.
 TELEPHONE = BELL SOUTH
3. PROPOSED SITE INFORMATION:
 ZONING = RUS (RESIDENTIAL-USE OF MEDIAN/STREET)
 LAND-USE DESIGNATION = RESIDENTIAL
4. PROPOSED PROJECT AND LOT INFORMATION:
 SINGLE-FAMILY CONCRETE-BLOCK DWELLING UNITS
 FRONT SETBACK = 20'
 REAR SETBACK = 20'
 SIDE YARD SETBACK = 5'
 SIDE YARD FOR CORNER LOTS = 20'
 MINIMUM LOT SIZE = 30' x 100'
 MINIMUM BLOCK FACING SIDE = 40' FEET
 MINIMUM FRONT YARD = 35'
 POOL & POOL DECK SETBACKS - REAR = 5'
 SIDE = 5'
5. INTERNAL ROADWAY INFORMATION:
 PRIVATE = NO ROAD OF RIGHT WITH Y ACCESS
 EASEMENT ON FRONT OF EACH LOT
6. PROJECT SITE'S CHARACTER:
 LOT 1 & 6 ARE 100' x 100' - INTERIOR FINE SANDS
 LOT 2, 3, 4, 5, 7, 8, 9, 10, 11, 12, 13, 14, 15, 16, 17, 18, 19, 20 ARE 100' x 100' - INTERIOR FINE SANDS
 LOT 21, 22, 23, 24, 25, 26, 27, 28, 29, 30 ARE 100' x 100' - INTERIOR FINE SANDS
 LOT 31, 32, 33, 34, 35, 36, 37, 38, 39, 40 ARE 100' x 100' - INTERIOR FINE SANDS
 LOT 41, 42, 43, 44, 45, 46, 47, 48, 49, 50 ARE 100' x 100' - INTERIOR FINE SANDS
 LOT 51, 52, 53, 54, 55, 56, 57, 58, 59, 60 ARE 100' x 100' - INTERIOR FINE SANDS
 LOT 61, 62, 63, 64, 65, 66, 67, 68, 69, 70 ARE 100' x 100' - INTERIOR FINE SANDS
 LOT 71, 72, 73, 74, 75, 76, 77, 78, 79, 80 ARE 100' x 100' - INTERIOR FINE SANDS
 LOT 81, 82, 83, 84, 85, 86, 87, 88, 89, 90 ARE 100' x 100' - INTERIOR FINE SANDS
 LOT 91, 92, 93, 94, 95, 96, 97, 98, 99, 100 ARE 100' x 100' - INTERIOR FINE SANDS
7. UTILITY PROVISIONS TO THE SITE:
 WATER - SEMINOLE COUNTY UTILITIES
 SEWER - SEMINOLE COUNTY UTILITIES
 ELECTRIC - FLORIDA POWER CORP.
 TELEPHONE - BELL SOUTH
 POINTS WATER CONNECTION TO AN EXISTING UTILITY WATER MAIN LOCATED WITHIN THE BANANA LAKE ROAD RIGHT-OF-WAY
 SANITARY SEWER CONNECTION TO A LIFT STATION AND FORCE MAIN TO AN EXISTING UTILITY SANITARY SEWER FORCE MAIN LOCATED WITHIN THE BANANA LAKE ROAD RIGHT-OF-WAY
 FIRE PROTECTION IS TO BE PROVIDED BY SEMINOLE COUNTY. ALL UTILITIES REGULATIONS PERTAINING TO THE REQUIRED FIRE FLOWS OF THE HIGHWAYS WILL BE MET.
 REGULATED WATER USE LINES WILL BE CONSTRUCTED WITHIN THIS SUBDIVISION AS PART OF THE INFRASTRUCTURE UPON COMPLETION/INSTALLATION OF THE REGULATED WATER MAIN ALONG BANANA LAKE ROAD. THE LINES INSTALLED WITHIN THIS SUBDIVISION WILL BE CONNECTED TO THE MAIN IN BANANA LAKE ROAD
8. FLOOD MANAGEMENT:
 47' BUFFER AT BANANA LAKE ROAD FRONTAGE
 30' BUFFER CONSISTING OF 15' CONCRAVE, 15' BUFFER AREA AND 6' HIGH BARRIER WALL WILL BE SET AS BUFFER TO THE NEAR-TURN POND WHERE A NATURAL VEGETATIVE BUFFER IS NOT PRESENT.
9. WETLANDS:
 WETLAND FLAGS WERE ESTABLISHED BY YVONNE FROSCHER.
 25' WETLAND BUFFER
10. 200' WIDE BUFFER BETWEEN COLONIAL GRAND APARTMENTS AND PROPOSED PROJECT
11. IMPACT ANALYSIS IS PROJECTED AS FOLLOWS:
 SCHOOLS: 43 (0) + 5 (25 PERSONS) PER = 120.75 + NET
 = 80 SCHOOL-AGED CHILDREN
 ROAD: 43 (0) + 4 (1,400) = 278.401
 WATER: 43 (0) + 7 (25,000) = 8,625.000
 SEWER: 43 (0) + 400 (100,000) = 40,000.000
12. TREE PRESERVATION/REMOVAL/REPLACEMENT:
 TREES WILL BE PLANTED ALONG PROPERTY RIGHT-OF-WAY LINES IN CONFORMANCE WITH SEMINOLE COUNTY STANDARDS. SHUBBS WILL BE PLANTED IN PARKS AND RECREATION SPACES AND HOMEOWNERS WILL APPLY FOR INDIVIDUAL APPROVEMENTS AS EACH LOT IS DEVELOPED.
13. TRANSPORTATION MANAGEMENT:
 STREETS INTERNAL TO THE SUBDIVISION WILL BE OWNED AND MAINTAINED BY HOMEOWNERS ASSOCIATION. A FIVE-FOOT WIDE SIDEWALK WILL BE PROVIDED ALONG THE PROPERTY FRONTAGE TO BANANA LAKE ROAD AND ALONG BOTH SIDES OF THE INTERNAL STREETS OF THE SUBDIVISION.
14. PRELIMINARY/PROPOSED LANDSCAPE PLAN:
 THE FIVE-FOOT WIDE SIDEWALKS WILL BE CONSTRUCTED ON BOTH SIDES OF ALL WALKWAYS CONSTRUCTED WITHIN THIS SUBDIVISION. ADDITIONAL PEDESTRIAN TRAILS AND/OR BIKEWAY PLANNING WILL BE ADDRESSED IN FINAL ENGINEERING PLANS.
15. COMMUNITY ACCESS TO BOTH BANANA LAKE AND ISLAND LAKES WILL BE MAINTAINED AND TO BE RETAINED IN FINAL ENGINEERING PLANS.
16. TOPOGRAPHY TAKEN FROM AERIAL PHOTO.
17. OTHER APPLICANT INFORMATION:
 OWNER = MR. TERRY A. GARDNER, 22064 THE BANANA LAKE ROAD, LAKE HAVEN, FLORIDA 32748
 PH: 407-353-1123
 FAX: 404-333-1131
 APPLICANT = MR. JAMES K. FERGUSON
 401 W. CENTRAL DRIVE, SUITE 1
 ORLANDO, FLORIDA 32804
 PH: 407-425-8778
 FAX: 407-425-8778

ENGINEERING & ARCHITECTURAL DESIGN, INC.
 1000 N. W. 10th St., Suite 100
 Ft. Lauderdale, FL 33304
 TEL: 754-561-1111
 FAX: 754-561-1112

**CONCEPTUAL PLAN
 BANANA LAKE VILLAS**

DATE: 01/28/2013
 DRAWN BY: J. GARDNER
 CHECKED BY: J. GARDNER
 PROJECT NO: 13-001
 SHEET NO: 1

H:\Projects\20130113\Banana Lake Road Subdivision\01-28-2013 01:13:31 PM PM.rvt

EXECUTIVE SUMMARY

Suburban Estates to Planned Development and Rezoning from A-1 (Agriculture) to PUD (Planned Unit Development)		Amendment 02S.FLU04 & Z2001-044
REQUEST		
APPLICANT	James H. Fant	
PLAN AMENDMENT	Suburban Estates to Planned Development	
REZONING	A-1 (Agriculture) to PUD (Planned Unit Development)	
APPROXIMATE GROSS ACRES	25.05 acres (including wetlands) 10.07 acres - developable	
LOCATION	West side of Banana Lake Road, approximately 3400' south of CR 46A	
SPECIAL ISSUES	<p>In 1998, to the south of the subject property, the Board approved a large scale land use amendment from Suburban Estates to Planned Development and associated rezoning from A-1 to PUD for Colonial Realty Limited Partnership. The plan amendment was found in compliance by the Department of Community Affairs (DCA), but Mr. Edwards, property owner, subsequently initiated administrative proceedings which resulted in a compliance agreement between the Colonial Realty, Mr. Edwards, the DCA, and the County. (Please see Exhibits A and B, attached) The Agreement restricted the development rights on a 200 foot strip of land between the Edwards' and Colonial Realty's properties. The developers of the Colonial Grand apartments deeded a portion of the 200 foot buffer to Mr. Edwards who agreed not to seek a rezoning or land use amendment on the strip deeded to him for a period of five (5) years from the effective date of the settlement agreement.</p>	
BOARD DISTRICT	#5 – Commissioner McLain	

Suburban Estates to Planned Development

Amendment
02S.FLU04
& Z2001-044

RECOMMENDATIONS AND ACTIONS

**STAFF
RECOMMENDATION
April 8, 2003**

PLAN AMENDMENT: Recommend transmittal of Planned Development land use with staff findings subject to the attached Development Order, but does not recommend adoption until the applicant has demonstrated the existence of sufficient ROW to improve the length of Banana Lake Road to County standards, that Planned Development land use, as proposed, would be:

1. Consistent with Plan policies related to the Planned Development land use designation; and
2. Consistent with adjacent Planned Development and Suburban Estates land uses; and
3. Consistent with development within the Heathrow International Business Center PUD to the east; and
4. Consistent with Plan policies related to roadway access; and
5. Consistent with Plan policies identified at this time.

**STAFF
RECOMMENDATION
April 8, 2003**

REZONE: Based on the above analysis and findings, staff recommends transmittal of the proposed PUD zoning with staff findings subject to the attached Development Order, but does not recommend adoption until the applicant has demonstrated the existence of sufficient ROW to improve the length of Banana Lake Road to County standards:

1. The request, with attached Development Order, would be compatible with surrounding development; and
2. The request, with the attached Development Order, would be consistent with the Seminole County Land Development Code regarding PUD zoning.

**LPA/P&Z
RECOMMENDATIONS
February 19, 2003**

Recommendations of the Planning and Zoning Commission will be presented at the hearing.

STAFF ANALYSIS

Suburban Estates to Planned Development and Rezoning from A-1 (Agriculture) to PUD (Planned Unit Development)

Amendment
02S.FLU04
& Z2001-044

1. **Property Owners:** Fred and Carmen Edwards
2. **Tax Parcel Numbers:** 01-20-29-300-0080-0000
01-20-29-300-0050-0000
01-20-29-300-0040-0000
3. **Applicant's Statement:** Planned Development land use allows the County to insure that adequate buffers will occur between the site and the adjacent single family residential neighborhoods. In addition, the proposed land use will insure that wetlands will be protected from development.
4. **Development Trends:** Development along Banana Lake Road has been large lot estates with single family residences. To the south of the subject property, development will consist of 252 multi-family units in two-story buildings on 28.5 acres. There is dense single family residential development to the west of the subject property. Finally, to the east is part of the Heathrow International Business Center.

SITE DESCRIPTION

1) EXISTING AND PERMITTED USES:

- a) The existing Suburban Estates land use and A-1 zoning would permit development of single-family homes at a net density of no greater than one dwelling unit per net buildable acre. The A-1 zoning district also permits a variety of agricultural and non-residential uses, such as churches.
- b) The requested Planned Development land use and PUD zoning, as proposed, would permit the development of single family homes and their accessory uses at a net density of approximately 6.05 dwelling units per acre.

Location	Future Land Use*	Zoning*	Existing Use
Site	Suburban Estates	A-1	<i>Single family residential</i>
North	Suburban Estates	A-1	Single family residential
South	Planned Development	PUD	Multi-family residential
East	City of Lake Mary	PUD	Heathrow International Business Center (HIBC)
West	Planned Development	PUD	Single family residential

* See enclosed future land use and zoning maps for more details.

COMPREHENSIVE PLAN CONSISTENCY

- 2) **PLAN PROGRAMS** - Plan policies address the continuance, expansion and initiation of new government service and facility programs, including, but not limited to, capital facility construction. Each application for a land use designation amendment will include a description and evaluation of any Plan programs (such as the affect on the timing/financing of these programs) that will be affected by the amendment if approved.

Summary of Program Impacts: The proposed amendment does not alter the options or long-range strategies for facility improvements or capacity additions included in the Support Documentation to the Vision 2020 Plan. The amendment request would not be in conflict with the Metroplan Orlando Plan or the Florida Department of Transportation's 5-Year Plan (Transportation Policy 14.1).

- a) **Traffic Circulation - Consistency with Future Land Use Element:** *In terms of all development proposals, the County shall impose a linkage between the Future Land Use Element and the Transportation Element and all land development activities shall be consistent with the adopted Future Land Use Element (Transportation Policy 2.1).*

Access to the subject property is via Banana Lake Road, a local road. There may be inadequate pavement width and right-of-way for Banana Lake. If approved, the developer shall be required to improve the length of Banana Lake Road to County standards. If there is at least fifty (50) feet of right-of-way (which remains to be demonstrated), the applicant has generally demonstrated to staff his plan and intent to modify Banana Lake Road to county standards is possible. Staff will review all final detailed improvements to the road at the final engineering stage of the approval process.

- b) **Water and Sewer Service – Adopted Potable Water and Sanitary Sewer Service Area Maps:** *Figure 11.1 and Figure 14.1 are the water and sewer service area maps for Seminole County.*

The subject properties are within the Seminole County Utilities water and sewer service area.

- c) **Public Safety – Adopted Level of Service:** *The County shall maintain adopted levels of service for fire protection and rescue...as an average response time of five minutes (Public Safety Policy 12.2.2).*

The property is served by the Seminole County EMS/Fire Rescue. Response time to the site is less than 5 minutes, which meets the County's average response time standard of 5 minutes.

- 3) **REGULATIONS** - The policies of the Plan also contain general regulatory guidelines and requirements for managing growth and protecting the environment. These guidelines will be used to evaluate the overall consistency of the land use amendment with the Vision 20/20 Plan, but are not applied in detail at this stage.

- a) **Preliminary Development Orders: Capacity Determination:** *For preliminary development orders and for final development orders under which no development activity impacting public facilities may ensue, the capacity of Category I and Category III public facilities shall be determined as follows...No rights to obtain final development orders under which development activity impacting public facilities may ensue, or to obtain development permits, nor any other rights to develop the subject property shall be deemed to have been granted or implied by the County's approval of the development order without a determination having previously been made that the capacity of public facilities will be available in accordance with law (Implementation Policy 1.2.3).*

A review of the availability of public facilities to serve these properties indicates that there would be adequate facilities to serve this area, and that the proposed Plan amendment would create no adverse impacts to public facilities. If approved, the developer shall improve the length of Banana Lake Road from County Road 46A to the project entrance to County standards.

In addition, the Banana Lake Road is planned for extension of reclaimed water main by the County which would be available in the future for connection to this site. The developer shall construct a reuse line to serve this development and commit to connecting to the County's system when it becomes available and pay any applicable fees.

- b) **Flood Plain and Wetlands Areas - Flood Plain Protection and Wetlands Protection:** *The County shall implement the Conservation land use designation through the regulation of development consistent with the Flood Prone (FP-1) and Wetlands (W-1) Overlay Zoning classifications...(Policy FLU 1.2 and 1.3).*

Approximately 15 acres are considered to be either wetlands and/or flood prone. A mitigation plan approved by the County and/or State shall be required at the time of Final PUD Master Plan approval for any proposed on-site wetland impacts. An undisturbed buffer averaging 25 feet and not less than 15 feet will be required landward of the on-site wetland limits.

- c) **Protection of Endangered and Threatened Wildlife:** *The County shall continue to require, as part of the Development Review Process, proposed development to coordinate those processes with all appropriate agencies and comply with the US Fish and Wildlife Service and the Florida Fish and Wildlife Conservation Commission Rules as well as other applicable Federal and State Laws regarding protection of endangered and threatened wildlife prior to development approval (Conservation Policy 3.13).*

A survey of threatened, endangered and species of special concern prior to final PUD master plan approval is required.

- 4) **DEVELOPMENT POLICIES** - Additional criteria and standards are also included in the Plan that describe when, where and how development is to occur. Plan development policies will be used to evaluate the appropriateness of the use, intensity, location, and timing of the proposed amendment.

- a) **Compatibility:** When the County's Future Land Use Map (FLUM) was developed in 1987, land use compatibility issues were evaluated and ultimately defined through a community meeting/hearing process that involved substantial public comment and input. When amendments are proposed to the FLUM, however, staff makes an initial evaluation of compatibility, prior to public input and comment, based upon a set of professional standards that include, but are not limited to criteria such as: (a) long standing community development patterns; (b) previous policy direction from the Board of County Commissioners; (c) other planning principles articulated in the Vision 2020 Plan (e.g., appropriate transitioning of land uses, protection of neighborhoods, protection of the environment, protection of private property rights, no creation of new strip commercial developments through plan amendments, etc.).

Based upon an initial evaluation of compatibility, Planned Development land use, as proposed, would be consistent with Plan policies identified at this time and therefore is consistent with the Seminole County Comprehensive Plan.

Applicable Plan policies include, but are not limited to, the following:

- 1) **Transitional Land Uses:** *The County shall evaluate plan amendments to insure that transitional land uses are provided as a buffer between residential and non-residential uses, between varying intensities of residential uses, and in managing the redevelopment of areas no longer appropriate as viable residential areas. "Exhibit FLU 2: Appropriate Transitional Land Uses" is to be used in determining appropriate transitional uses. (Policy FLU 2.5)*

Transition of land use and associated compatibility issues will be addressed through the use of the Planned Development land use designation and PUD. Staff believes that the prepared PUD plan provides for creative site design and appropriate standards for buffering, setbacks, lighting and building height, and that the request meets the intent of the Planned Development definition and PUD zoning classification.

Staff's primary concern is access to the site. The sole access to the site is via Banana Lake Road, a substandard local road. The applicant has not demonstrated the ability to improve the road to County standards. The 1998 approval of multi-family to the south was based in part on the applicant's ability to access the site through the existing apartments within the Heathrow International Business Center to the south. Staff indicated at that time that the orientation of the project towards a developed, higher-intensity PUD was a mitigating factor in the placement of high density uses at that location.

Other applicable Plan policies include, but are not limited to:

Policy DES 1.9: Tree Canopy and Natural Vegetation

Policy DES 2.8: Visual Quality of Streets and Highways

Policy DES 30.3: Preserve and Protect Neighborhoods

Policy FLU 1.1: Conservation Land Use

Policy FLU 1.2: Floodplain Protections

Policy FLU 1.3: Wetlands Protection

Policy FLU 1.4: Conservation Easements

Policy FLU 2.11: Determination of Compatibility in the Planned Unit Development and Planned Commercial Development Zoning Classifications

Potable Water Policy 11.4.5: Extension of Service to New Development

Sanitary Sewer Policy 14.4.4: Extension of Service to New Development

Policy TRA 10.3: Review of Development Applications

- b) **Concurrency Review - Application to New Development:** *For purposes of approving new development subsequent to adoption of this Comprehensive Plan, all adopted public safety level of service standards and schedules of capital improvements...shall be applied and evaluated...consistent with policies of the Implementation Element... (Capital Improvements Policy 3.2).*

This policy provides for the adoption of level of service (LOS) standards for public facilities and requires that final development orders be issued only if public facilities meeting the adopted LOS are available or will be available concurrent with the development. Additionally, preliminary development orders shall only be issued with the condition that no rights to obtain final development orders or development permits, nor any other rights to develop the subject property are granted or implied by the County's approval of the preliminary development order.

- 5) **COORDINATION** - Each application for a land use designation amendment will be evaluated to assess how and to what extent any additional intergovernmental coordination activities should be addressed.

- a) **Plan Coordination:** *The County shall continue to coordinate its comprehensive planning activities with the plans and programs of the School Board, major utilities, quasi-public agencies and other local governments providing services but not having regulatory authority over the use of land (Intergovernmental Coordination Policy 8.2.12). Seminole County shall coordinate its comprehensive planning activities with the plans and programs of regional, State and Federal agencies by...as the County is now a charter County (Intergovernmental Coordination Policy 8.3.3).*

The Vision 2020 Plan fully complies with the State Comprehensive Plan adopted pursuant to Chapter 187, Florida Statutes, and the Strategic Regional Policy Plan of the East Central Florida Regional Planning Council pursuant to Chapter 163, Florida Statutes. Consistency with the State Plan and the Regional Policy Plan will be evaluated by individual review agencies during the Plan amendment review process.

STAFF RECOMMENDATION

Planning staff recommends transmittal of Planned Development land use with staff findings; and rezoning from A-1 (Agriculture) to PUD (Planned Unit Development) with staff findings subject to the attached Development Order, but does not recommend adoption until the applicant has demonstrated the existence of sufficient ROW to improve the length of Banana Lake Road to County standards.

LPA/P&Z RECOMMENDATION

At its meeting of February 19, 2003, the Planning and Zoning Commission recommended denial.

FILE #

Z2001-044 02s.FLU04

DEVELOPMENT ORDER #01-23000005

**SEMINOLE COUNTY DEVELOPMENT
ORDER**

On June 10, 2003, Seminole County issued this Development Order relating to and touching and concerning the following described property:

Legal description attached as Exhibit A.

(The aforescribed legal description has been provided to Seminole County by the owner of the aforescribed property.)

FINDINGS OF FACT

Property Owners: FRED C. AND CARMEN S. EDWARDS
748 BANANA LAKE RD
LAKE MARY, FL 32746

Project Name: BANANA LAKE LAND USE AMEND. LARGE / REZONE

Requested Development Approval: Rezoning from A-1 (Agriculture) zoning classification to Planned Unit Development (PUD) zoning classification

The Development Approval sought is consistent with the Seminole County Comprehensive Plan and will be developed consistent with and in compliance to applicable land development regulations and all other applicable regulations and ordinances.

The owner of the property has expressly agreed to be bound by and subject to the development conditions and commitments stated below and has covenanted and agreed to have such conditions and commitments run with, follow and perpetually burden the aforescribed property.

Prepared by: KENT CICHON
1101 East First Street
Sanford, Florida 32771

NOW, THEREFORE, IT IS ORDERED AND AGREED THAT:

- (1) The aforementioned application for development approval is **GRANTED**.
- (2) All development shall fully comply with all of the codes and ordinances in effect in Seminole County at the time of issuance of permits including all impact fee ordinances.
- (3) This development is subject to the Settlement Agreement (DOAH CASE NO.: 99-0133GM) entered into by and between the State of Florida, Department of Community Affairs; Seminole County, Florida; Colonial Properties Trust, as general partner of Colonial Realty Properties Limited Partnership; and Fred Edwards, Jr. (attached hereto as Exhibit B).
- (4) The further conditions upon this development approval and the commitments made as to this development approval, all of which have been accepted by and agreed to by the owner of the property are as follows:
 - a. The developer shall be required to improve the length of Banana Lake Road to County standards.
 - b. The Banana Lake Road is part of a planned County extension of a reclaimed water main. This water main would be available in the future for connection from the development subject to this agreement. The developer shall construct a reuse line to serve this development and connect to the County's reclaimed water main when it becomes available and pay any applicable fees for such connection.
 - c. The maximum number of dwelling units shall not exceed 43 units.
 - d. The net density shall not exceed 6.05 du/ac.
 - e. There shall be the following minimum building setbacks for each home:
 - 20' front
 - 20' rear
 - 5' side yard
 - 20' side street (corner lots).
 - f. There shall be the following minimum setbacks for accessory structures of a size of 200 square feet or less:
 - 5' rear
 - 5' side yard
 - 20' side street (corner lots).

- g. There shall be the following minimum setbacks for accessory structures in excess 200 square feet:
 - 20' rear
 - 5' side yard
 - 20' side street (corner lots).
- h. All accessory structures in front yard shall be located behind the front building line of the dwelling unit.
- i. Minimum lot sizes and widths shall be 5,000 square feet with a minimum 50' width at building line. Corner lots shall be 15% larger and 15% wider than the aforementioned minimum lot sizes and widths.
- j. Maximum building height shall be 35'.
- k. Minimum pool and pool screen setbacks shall be 5' rear and 5' side.
- l. 5' wide sidewalks shall be constructed on both sides of all roadways constructed within this development.
- m. Open space and recreational amenities shall be determined during the review of the Final Master Plan.

(5) This Development Order touches and concerns the aforescribed property and the conditions, commitments and provisions of this Development Order shall perpetually burden, run with and follow the said property and be a servitude upon and binding upon said property unless released in whole or part by action of Seminole County by virtue of a document of equal dignity herewith. The owner of the said property has expressly covenanted and agreed to this provision and all other terms and provisions of this Development Order.

(6) The terms and provisions of this Order are not severable and in the event any portion of this Order shall be found to be invalid or illegal then the entire order shall be null and void.

Done and Ordered on the date first written above.

ATTEST:

BOARD OF COUNTY COMMISSIONERS
SEMINOLE COUNTY, FLORIDA

By: _____

MARYANNE MORSE
**Clerk to the Board of County
Commissioners of Seminole
County, Florida**

DARYL G. Mc LAIN, Chairman

FILE # Z2001-044 02s.FLU04

DEVELOPMENT ORDER #01-23000005

OWNER'S CONSENT AND COVENANT

COMES NOW, the owner, Fred C. Edwards Jr., on behalf of himself and his heirs, successors, assigns or transferees of any nature whatsoever and consents to, agrees with and covenants to perform and fully abide by the provisions, terms, conditions and commitments set forth in this Development Order.

Witness

FRED C. EDWARDS JR

Print Name

Witness

Print Name

STATE OF FLORIDA

COUNTY OF SEMINOLE

I HEREBY CERTIFY that on this day, before me, an officer duly authorized in the State and County aforesaid to take acknowledgments, personally appeared FRED C. EDWARDS JR., and is personally known to me or who has produced _____ as identification and who acknowledged and executed the foregoing instrument.

WITNESS my hand and official seal in the County and State last aforesaid this _____ day of _____, 2003.

Notary Public, in and for the County and State
Aforementioned

My Commission Expires:

FILE # Z2001-044 02s.FLU04

DEVELOPMENT ORDER #01-23000005

OWNER'S CONSENT AND COVENANT

COMES NOW, the owner, Carmen S. Edwards, on behalf of herself and her heirs, successors, assigns or transferees of any nature whatsoever and consents to, agrees with and covenants to perform and fully abide by the provisions, terms, conditions and commitments set forth in this Development Order.

Witness

CARMEN S. EDWARDS

Print Name

Witness

Print Name

STATE OF FLORIDA

COUNTY OF SEMINOLE

I HEREBY CERTIFY that on this day, before me, an officer duly authorized in the State and County aforesaid to take acknowledgments, personally appeared CARMEN S. EDWARDS, and is personally known to me or who has produced _____ as identification and who acknowledged and executed the foregoing instrument.

WITNESS my hand and official seal in the County and State last aforesaid this _____ day of _____, 2003.

Notary Public, in and for the County and State
Aforementioned

My Commission Expires:

EXHIBIT A

LEGAL DESCRIPTION

COMMENCE at the Northeast corner of Government on Lot 2, Section 1, Township 20 South, Range 29 East, said corner being a point on the Center Line of Banana Lake Road as shown on the Plat at Banana Lake Road as recorded in Plat Book 4 Page 72 of the public records of Seminole County, Florida; thence run North 89° 38' 43" West along the North Line of said Government Lot 2 a distance of 25.00 feet to a point lying on the Westerly right-of-way line of Banana Lake Road; thence continue North 89° 38' 43" West, 867.49 feet to the POINT OF BEGINNING of this description; thence continue North 89° 38' 43" West a distance of 892.49 feet; thence South 00° 42' 36" West a distance of 817.00 feet; thence South 89° 38' 40" East a distance of 1766.79 feet to a point on the aforementioned Westerly right-of-way line of Banana Lake Road; thence run North 00° 13' 57" East along said right-of-way line 277.00 feet; thence departing said right-of-way line, run North 76° 33' 03" West, 524.00 feet; thence North 00° 13' 57" East, 130.20 feet; thence North 89° 38' 43" West, 358.87 feet; thence run North 00° 31' 44" East, 291.00 feet to the POINT OF BEGINNING.

Containing 25.05 acres more or less.

Typed Copy

EXHIBIT B

STATE OF FLORIDA
DIVISION OF ADMINISTRATIVE HEARINGS

FRED C. EDWARDS, JR.,

Petitioner,

DOAH CASE NO.: 99-0133GM

vs.

DEPARTMENT OF COMMUNITY
AFFAIRS AND SEMINOLE COUNTY,

Respondents,

and

COLONIAL PROPERTIES, INC.,

Intervenor .

SETTLEMENT AGREEMENT

This Settlement Agreement is entered into by and between the State of Florida, Department of Community Affairs (hereinafter "DCA"); Seminole County, Florida (hereinafter "Seminole County"); Colonial Properties Trust, as general partner of Colonial Realty Properties Limited Partnership (hereinafter "Colonial"); and Fred C. Edwards, Jr. (hereinafter "Edwards"), the parties being all of the parties to the above-styled proceeding, as a complete and final settlement of all claims raised in the above-styled proceedings.

WHEREAS, DCA is the state land planning agency and has the authority to administer and enforce the Local Government Comprehensive Planning and Land Development Regulation Act, Chapter 163, Part II, Florida Statutes; and

WHEREAS, Seminole County on or about October 13, 1998 approved the request of Colonial to amend the Seminole County Comprehensive Plan by adopting Ordinance No. 98-46 approving Seminole County Comprehensive Plan Amendment 98S.FLU5, which re-designated the future land use of that certain property therein described from Suburban Estates to PD; and

concurrently approved the rezoning of the said property from Agriculture to PUD, allowing development of multi-family apartments in accordance with the PUD plan, subject to various conditions; and

WHEREAS, on or about December 9, 1998 DCA issued a Notice of Intent to find Seminole County Comprehensive Plan Amendment 98S.FLU5 "in compliance" with Sections 163.3177, 163.3178, 163.3180, 163.3191, 187.201, Florida Statutes, the applicable strategic regional plan and Chapter 9J-5, Florida Administrative Code; and

WHEREAS, Edwards, as an affected person pursuant to Section 163.3184, Florida Statutes, has initiated the above-styled formal administrative proceeding challenging Seminole County Comprehensive Plan Amendment 98S.FLU5; and

WHEREAS, Colonial has intervened in the above-styled proceeding; and

WHEREAS, the parties wish to avoid the expense and delay of lengthy litigation and future appellate proceedings, and to resolve this proceeding under the terms set forth herein, and it is in their respective mutual best interests to do so;

NOW, THEREFORE, in consideration of the mutual covenants and undertakings herein below set forth, and in consideration of the benefits to accrue to each of the parties, the receipt and sufficiency of which are hereby acknowledged, the parties hereby agree as follows:

1. Effective Date. This Settlement Agreement shall not become effective until approved by the Board of County Commissioners of Seminole County at a duly noticed public meeting, and executed by each of the parties hereto. The effective date shall be the date of signing by the last party signing.

2. Dismissal of Administrative Proceeding. Upon this Settlement Agreement becoming effective, the parties shall file a stipulated notice of dismissal with prejudice in the

above-styled proceeding in the form attached hereto as Exhibit A, with each party to bear its own attorneys fees and costs.

3. Abatement. The parties acknowledge that they have had their respective counsel join in a Notice of Pending Settlement and Request for Stay of Proceedings, a copy of which is attached hereto as Exhibit B, in order to allow sufficient time for the preparation and implementation of this Settlement Agreement.

4. Final Order Approving Plan Amendment. Upon filing of the Stipulated Notice of Dismissal, Seminole County Comprehensive Plan Amendment 98S.FLU5 shall stand approved and DCA shall issue a final order determining it to be in compliance in accordance with Section 163.3184, Florida Statutes.

5. Enhancement of Buffer Conditions. The parties acknowledge that the PUD zoning of the property which is the subject of Seminole County Comprehensive Plan Amendment 98S.FLU5 was approved by Seminole County with various conditions, among which were the establishment of a 200-foot wide buffer area along the northern boundary of the said property, with the said buffer to be comprised as follows:

a. A 15-foot wide area along the northern boundary to be planted with a double row of off-set trees;

b. A 6-foot wall on a 2-foot berm, or a 5-foot wall on a 3-foot berm, to be located at least fifteen (15) feet from the northern boundary;

c. A double row of off set trees to be planted south of the wall described in item (b);

d. No structures or parking lots to be located in the 200-foot buffer, except the southern one hundred fifty (150) feet of the said buffer may be utilized for stormwater control and retention facilities.

The parties agree that the said conditions shall be enhanced to provide for the 200-foot wide buffer to be comprised as follows:

- i. A 6-foot wall on a 2-foot berm, or a 5-foot wall on a 3-foot berm, to be located at least sixty-one (61) feet from the northern boundary of the PUD, except the wall may be located fifteen (15) feet from the northern boundary as depicted on the sketch attached hereto as Exhibit "C"; and in the one hundred year flood plain area adjacent to Island Lake in lieu of the wall an 8-foot tall vinyl-coated chain link fence may be installed to the normal high water elevation of Island Lake;
- ii. A row of off-set trees to be planted within the area fifteen (15) feet north of the above-described wall;
- iii. A row of off-set trees to be planted south of the above-described wall;
- iv. No structures or parking lots to be located in the 200-foot buffer, except stormwater control and retention facilities may be located in that portion of the buffer area located south of the above-described wall.

Colonial, or its successor developer, shall bear the cost and perform the work appropriate to establish each element of the said buffer. Edwards shall bear the cost and perform the work of maintaining and irrigating trees planted on the Exhibit "C" Property (as hereinbelow described) upon the Exhibit "C" Property being conveyed to him. The parties acknowledge and agree that the above-stated enhancements of the buffer conditions do not affect the intent or character of the development proposed by Colonial and therefore do not constitute a major or substantial

change in the approved PUD. The enhanced conditions shall be effective upon approval of this Settlement Agreement by the Seminole County Board of County Commissioner and shall be completed as provided in the Development Order to be issued by Seminole County. The parties agree that this Settlement Agreement shall be attached to and incorporated by reference in the Development Order issued by Seminole County authorizing Colonial's proposed development, which shall include as conditions for development that Colonial, or its successor developer, comply with and perform all obligations established by this Settlement Agreement. The Development Order shall further provide that no modifications of the Development Order may alter or amend the foregoing enhanced buffer conditions without a formal major amendment to the PUD being duly processed and approved after hearing upon notice to all affected persons, including but not limited to Edwards, his heirs, successors and assigns.

6. Conveyance of Property to Edwards. Colonial represents to Edwards that it owns the property which is the subject of Seminole County Comprehensive Plan Amendment 98S.FLU5, except for that certain property owned by Duke University (hereinafter referred to as "the Duke Property"). The legal description of the property which is the subject of Seminole County Comprehensive Plan Amendment 98S.FLU5 is as follows:

Begin at point 896.8 feet East and 164 feet North of the Northeast corner of the South ½ of Section 1, Township 20 South, Range 29 East, thence run East 895.5 feet to the East line of said Section, thence along said line 344.4 feet, thence West 1236.1 feet to the Northeast corner of Lot 8 of Island Lake Park as recorded in Plat Book 9, Page 89 of the Public Records of Seminole County, Florida; thence South 45 ° along the Northeasterly corner of Lot 8, Island Lake Park 522.41 feet to the point of beginning.

and

Lot 8, ISLAND LAKE PARK, according to the Plat thereof as recorded in Plat Book 9, Page 89 of the Public Records of Seminole County, Florida.

and

Lots 1 through 7, ISLAND LAKE PARK, according to the plat thereof as recorded in Plat Book 8, Page 89 of the Public Records of Seminole County, Florida.

(hereinafter referred to as "the Development Property"). Colonial further represents to Edwards that it has entered into a contract to purchase the Duke Property and that the said contract obligates Colonial to purchase the Duke Property subject to various conditions, among which is the condition that Colonial obtain development approvals and permits authorizing Colonial's proposed development. The legal description of the Duke Property is as follows:

Begin at point 896.8 feet East and 164 feet North of the Northeast corner of the South ½ of Section 1, Township 20 South, Range 29 East, thence run East 895.5 feet to the East line of said Section, thence along said line 344.4 feet, thence West 1236.1 feet to the Northeast corner of Lot 8 of Island Lake Park as recorded in Plat Book 9, Page 89 of the Public Records of Seminole County, Florida; thence South 45°E. along the Northeasterly line of Lot 8, Island Lake Park 522.41 feet to the point of beginning.

Colonial, on behalf of itself, its affiliated companies, successors and assigns, hereby agrees to sell to Edwards, and Edwards hereby agrees to buy that certain portion of the Development Property, described as follows:

A PARCEL OF LAND LOCATED IN THE NORTH ½ OF THE SOUTHWEST ¼ OF SECTION 1, TOWNSHIP 20 SOUTH, RANGE 29 EAST, SEMINOLE COUNTY, FLORIDA, BEING DESCRIBED AS FOLLOWS:

BEGIN AT THE NORTH EAST CORNER OF LOT 8, ISLAND LAKE PARK, AS SHOWN IN PLAT BOOK 9, PAGE 89, OF THE PUBLIC RECORDS OF SEMINOLE COUNTY, FLORIDA. THENCE RUN S89°52'48"E, A DISTANCE OF 1239.44 FEET TO THE CENTER LINE OF THE EXISTING 50 FOOT WIDE BANANA LAKE ROAD RIGHT-OF-WAY (TO BE VACATED); THENCE S00°21'30"E, ALONG THE CENTERLINE OF SAID BANANA LAKE ROAD RIGHT-OF-WAY 60.00 FEET; THENCE DEPARTING SAID CENTERLINE, RUN N89°52'48"W, A DISTANCE OF 955.00 FEET; THENCE N44°52'48"W, A DISTANCE OF 63.64 FEET; THENCE N89°52'48"W, A DISTANCE OF 244.35 FEET TO THE EASTERLY LINE OF THE AFORESAID LOTS 7 AND 8 OF ISLAND LAKE PARK; THENCE N44°34'00"W, ALONG

SAID EASTERLY LOT LINE, A DISTANCE OF 21.10 FEET,
TO THE POINT OF BEGINNING.

CONTAINING 1.434 ACRES MORE OR LESS

(referenced to herein as "the Exhibit "C" Property") or such portion of the Exhibit "C" Property as to which Colonial, its affiliated companies, successors and assigns, possess title currently or at any time in the future, including all of Colonial's rights, title, after acquired title, and interest in, on, and to all improvements, fixtures, easements, rights-of-way, licenses, privileges, tenements, reversions and appurtenances belonging or appertaining to the 60-foot Property, on the terms and conditions set forth below. In the event Colonial, its successors, assigns or an affiliated company, does not purchase the Duke Property, whether pursuant to the existing contract or an amended, modified, extended or substituted contract, Colonial's obligation under this Paragraph (6) shall be limited to selling to Edwards that portion of the Exhibit "C" Property which Colonial does own or hereafter acquires, with the obligation to convey to Edwards any remaining portion of the Exhibit "C" Property remaining a development condition under the Development Order to be entered by Seminole County. In the event Colonial's contract to acquire the Duke Property is terminated, and in the future Colonial, or an affiliated company or a person in privity with Colonial, nonetheless acquires the Duke Property, or any portions thereof, by a different contract or by other means, the obligations of this Settlement Agreement shall continue in effect and any portion of the Exhibit "C" Property not previously conveyed to Edwards shall be promptly conveyed by Colonial, its successors, assigns, or affiliates, to Edwards on the terms hereinbelow set forth. The terms and conditions for the sale and purchase of the Exhibit "C" Property, or any portion thereof in the event the ownership is of less than all of the Exhibit "C" Property, shall be as follows:

- a. The purchase price shall be \$1 .00, payable at Closing.

b. Within thirty (30) days of Colonial acquiring the Duke Property, or any portion thereof, Colonial, and such other owners of any portion of the Exhibit "C" Property as may then be, shall convey to Edwards fee simple title to the Exhibit "C" Property, or such portion thereof as is owned by Colonial, or such other owners as may then be, by general warranty deed(s) subject only to: (A) real estate taxes and special assessments for the year of Closing, (B) the PUD conditions applicable to the Exhibit "C" Property as set forth above in this Settlement Agreement, and (C) the easement for ingress and egress to the Edwards' home located at 748 Banana Lake Road, Lake Mary, Florida. No representation or title warranties are made or will be made with respect to the beds or bottoms of lakes, rivers or other bodies of water located on, contiguous to or within the Exhibit "C" Property. The date for delivery of said general warranty deed to Edwards shall be the Closing Date.

c. There shall be no mechanics' liens, construction liens, claims of lien or other claims against the property conveyed except governmental assessments, and all bills for all work done or materials supplied to the property conveyed will have been paid as of delivery of the general warranty deed(s) to Edwards. This representation will be true at Closing and shall survive Closing. Colonial agrees to indemnify and hold Edwards harmless from any unrecorded liens, claims of lien or other claims against the Exhibit "C" Property occurring or arising for work or services performed prior to the Closing Date. At closing there shall be delivered to Edwards, and/or a Title Company issuing a Commitment, an affidavit in form sufficient to allow a Title Company to insure the gap at the time of Closing. In addition, the grantor(s) of the deed(s) shall cause to be eliminated from the title insurance policy the printed exceptions for unrecorded mechanics' liens, parties in possession, unrecorded easements, and survey exceptions (if a survey is obtained by Edwards), and taxes or special assessments not shown as existing liens by the public records, other than those for the year of Closing which are not yet due and payable.

d. From and after the effective date of this Settlement Agreement, Colonial shall not, without obtaining Edwards' prior written consent in each instance, create, incur, consent to or permit to exist, any easement, restriction, right-of-way, reservation, mortgage, lien, pledge, encumbrance, lease, license, occupancy agreement or other legal or equitable interest, which encumbers the Exhibit "C" Property or any portion thereof, other than the PUD conditions applicable to the Exhibit "C" property as set forth above in this Settlement Agreement.

e. In the event Edwards obtains an owner's marketable title insurance policy or obtains a survey of the Exhibit "C" Property, same shall be at his own expense.

f. Edwards shall pay for documentary stamps on the warranty deed and Colonial shall pay for recording curative instruments. Edwards shall bear the costs of title searches and updates, and the Title Policy if one is obtained. Edwards shall pay for the survey, if one is obtained, the cost of recording the warranty deed, and for any title endorsements required by Edwards. Edwards

shall pay the cost of preparing closing documents and any closing fees in connection therewith. Each party shall pay its own respective attorneys fees.

g. Real and personal property taxes for the year of Closing, installments on public improvement liens, special assessments, municipal services taxing unit charges, rents, and insurance premiums, if any, and other proratable items pertaining to the Exhibit "C" Property shall be prorated as of the Closing Date. Colonial's prorata share of such taxes, assessments and MSTU charges as determined by the Seminole County Property Appraiser, the Seminole County Tax Collector and/or other applicable governmental authority shall be paid at Closing to the Seminole County Tax Collector's office. Delivery of such tax payment to the Seminole County Tax Collector's office shall be the responsibility of Edwards and shall occur immediately after Closing. Edwards shall incur the proratable expenses for the Closing Date. All real estate special assessments, personal property taxes and ad valorem taxes for prior years shall be paid by Colonial. For proration purposes, it will be assumed real estate and personal property taxes are paid upon the tax due date. If the real property ad valorem taxes, personal property taxes, general assessments and MSTU charges applicable to the Exhibit "C" Property are not available at Closing, then they shall be estimated upon the most recent information available. If the foregoing are estimated, Colonial agrees to pay any unpaid amounts once the bill for same is received. Colonial shall receive any refund that may be due from Seminole County for overpayment. Edwards shall have no obligations for any assessments relative to infrastructure improvements benefiting the PUD, either before or after Closing.

h. No default in regard to the purchase and sale of the Exhibit "C" Property shall be claimed or charged by Edwards or Colonial against the other until notice of thereof has been given to the defaulting party in writing, and such default remains uncured for a period of ten (10) days after the defaulting's party's receipt of such notice. Notwithstanding the foregoing, the Closing Date shall not be changed, delayed, postponed or extended by any requirement for notice of default, if such default consists of failure to appear at Closing. In the event Edwards defaults on his obligation to purchase the Exhibit "C" Property and the conditions precedent to Edwards' obligation to purchase same have been fulfilled in the time(s) required herein, and provided Colonial is not in default, then Colonial's sole remedies shall be, upon giving written notice to Edwards, as hereinabove provided, to discover damages, specific performance or obtain injunctive relief, but Colonial may not rescind or terminate this Settlement Agreement unless Colonial affirmatively acts to bring about the repeal or cancellation of Seminole County Comprehensive Plan Amendment 98S.FLU5, so as to re-establish the Suburban Estates land use designation for the Development Property. In the event Colonial refuses or is unable to comply with and perform in accordance with the provisions of this Settlement Agreement for the purchase and sale of the Exhibit "C" Property, and provided Edwards is not in default, Edwards may elect to seek enforcement of the development conditions in the Development Order, seek specific performance, obtain injunctive relief or recover damages, but may not rescind or terminate this Settlement Agreement.

i. Colonial hereby represents and warrants to Edwards that it has full power, right, and authority, and is duly authorized to enter into this Settlement Agreement, and perform each and all of the matters and acts herein provided in connection therewith, and to execute and deliver all documents provided hereunder in connection with such sale and purchase; and that the purchase and sale of the Exhibit "C" Property in accordance with the terms and obligations hereof, does not contravene any provisions of law, trust, indenture, or agreement binding upon Colonial, and that when executed, the instruments required hereunder shall constitute valid and binding obligations of Colonial in accordance with their terms. Colonial agrees to provide Edwards with copies of all environmental inspection reports currently in its possession, custody or control relating to the Exhibit "C" Property, or which came into its possession, custody or control prior to the conveyance of title to Edwards.

j. The provisions of all subsections of this Paragraph 6 of this Settlement Agreement concerning purchase and sale of the Exhibit "C" Property, including the representations and warranties set forth therein, are intended to survive the Closing, shall so survive, and shall not be merged into the warranty deed.

k. Any notices which may be permitted or required hereunder shall be in writing and shall be deemed to be duly given as of the date and time the same are personally delivered, transmitted electronically (i.e., facsimile transmission) or within three (3) days after depositing with United States postal service, postage prepaid by registered or certified mail, return receipt requested, or within one (1) day after depositing with Federal Express or other overnight delivery service, from which a receipt may be obtained, and addressed as follows:

To Colonial: Colonial Properties Trust
c/o Charles A. McGehee
Executive Vice President
Suite 750
2101 6th Avenue, North
Birmingham, Alabama 35202

With copy to: Kenneth W. Wright, Esquire
Shutts & Bowen, LLP
20 North Orange Avenue
Suite 1000
Orlando, Florida 32801-4626
Telephone: (407) 423-3200
Facsimile: (407) 425-8316

To Edwards: Fred C. Edwards, Jr.
748 Banana Lake Road
Lake Mary, Florida 32746

With copy to:

Michael P. McMahon, Esquire
Akerman, Senterfitt & Eidson, P.A.
Post Office Box 231
Orlando, Florida 32802-023 1
Telephone: (407) 843-7860
Facsimile: (407) 843-66 10

Edwards and Colonial may from time to time notify the other of changes with respect to where and to whom notices should be sent.

7. Future Plan Amendment/Rezoning. Colonial agrees with Edwards that if in the future Edwards desires to have the Exhibit "C" Property rezoned and/or have the Seminole County Comprehensive Plan land use designation of the Exhibit "C" Property amended to authorize a residential zoning or land use, that Colonial, its successors and assigns, will consent thereto and shall not object thereto. The parties acknowledge and stipulate that neither Seminole County nor DCA make any agreement or commitment in regard to any possible future re-designation of authorized land use of the Exhibit "C" Property under the Seminole County Comprehensive Plan, nor in regard to any possible future rezoning of the Exhibit "C" Property.

8. DCA/Seminole County Not Parties to Purchase/Sale. It is acknowledged and agreed that neither Seminole County nor DCA are obligated by the purchase and sale provisions of Paragraph 6 of this Settlement Agreement; and that, while each has knowledge of the transaction contemplated by Paragraph (6) and does not object thereto, neither Seminole County nor DCA shall have any liability for performance or non-performance of any of the purchase and sale provisions of Paragraph (6) by either Colonial or Edwards, their successor developers or assigns.

9. Rezoning: Freeze. Edwards, on behalf of himself, his successors and assigns, hereby agrees, and commits to Seminole County that upon-conveyance of the Exhibit "C" Property, or any portion thereof, to Edwards, his successors or assigns, he shall not seek an amendment to the Seminole County Comprehensive Plan proposing a re-designation; or the

authorized land use of the Exhibit "C" Property nor seek a re-zoning of the Exhibit "C" Property for a period of five (5) years from the effective date of this Settlement Agreement. In the event the Exhibit "C" Property is not conveyed to Edwards, his successors and assigns, as contemplated under Paragraph (6), above, Edwards shall not be limited in his rights by the provisions hereof.

10. Exclusion From DRI. The parties acknowledge that Colonial intends to seek inclusion of its proposed development of a multi-family apartment project in the Heathrow International Business Center DRI ("HIBC"). It is hereby agreed that the Exhibit "C" Property shall not be made a part of the HIBC, nor any other Development of Regional Impact, without the express written consent and affirmative joinder of Edwards, which Edwards may withhold in his absolute personal discretion. It is acknowledged that Edwards intends to refuse to consent to the Exhibit "C" Property being joined into any DRI. The parties acknowledge that Seminole County may include the Exhibit "C" Property in its calculations for density requirements for purposes of the PUD and HIBC DRI approvals to the extent doing so does not limit Edwards, his successors and assigns, from installing a public street on the Exhibit "C" Property in the future.

11. Waiver of Future Opposition. Edwards, on behalf of himself, his successors and assigns, agrees that upon the effective date of this Settlement Agreement, unless this Settlement Agreement is terminated in accordance with the terms hereof, he shall not take any action in opposition to the proposed development project of Colonial, as long as same remains consistent with the PUD conditions approved by Seminole County prior hereto, and as enhanced by the provisions of this Settlement Agreement, and shall not oppose the inclusion of Colonial's proposed development in the Heathrow DRI, excepting as to the Exhibit "C" Property. Edwards agrees to cooperate with Colonial to extent of communicating non-objection and

consent in writing to governmental agencies reviewing or permitting any aspect of Colonial's proposed development, and personally appearing at public hearings conducted in Seminole County, Florida on a date and at a time when Edwards is in Seminole County and not previously engaged, subject to there being no modification of the proposed development inconsistent with the PUD conditions approved by Seminole County on or about October 13, 1998, as enhanced by the provisions of this Settlement Agreement.

12. No Establishment of Precedent. The parties enter into this Settlement Agreement in a spirit of cooperation for the purposes of resolving disputes which have arisen between them. The acceptance of proposals for purposes of this Settlement Agreement is part of a negotiated agreement affecting many factual and legal issues and is not an endorsement of, and does not establish precedent for, the use of these proposals in any other circumstances or by any other governmental body.

13. Multiple Originals/Facsimiles/Counterparts. This Settlement Agreement may be executed in any number of originals, all of which evidence one agreement, and only one of which need be produced for any purpose. This Settlement Agreement may be executed by facsimile transmission and in counterparts, all of which taken together shall constitute a single complete agreement.

14. Captions. The captions inserted in this Settlement Agreement are for the purpose of convenience only and shall not be utilized to construe or interpret any provision of this Settlement Agreement.

15. Successors and Assigns. The rights and obligations established by this Settlement Agreement shall be binding upon and shall accrue to the benefit of the successors, assigns and heirs of the parties hereto. It is agreed that Edwards may assign his right to receive the

conveyance of title to the Exhibit "C" Property to Fred C. Edwards, Jr., as Trustee of the Fred C. Edwards, Jr. Living Trust.

IN WITNESS WHEREOF, the parties have caused this Settlement Agreement to be signed as of the dates indicated hereinbelow.

Barbara R. Mascia
Witness (Signature)

BARBARA R. MASCIA
Witness (Print Name)

[Signature]
Witness (Signature)

Michael P. McMath
Witness (Print Name)

Fred C. Edwards Jr.
FRED C. EDWARDS, JR.

Date: July 29, 1999

DEPARTMENT OF COMMUNITY AFFAIRS

By: J. Thomas Beck
J. Thomas Beck, Director
Division of Community Planning

Date: August 16, 1989

SEMINOLE COUNTY, FLORIDA

By: Carston Henley
Chairman
Board of County Commissioners

Approved by the Seminole County Board of County Commissioners on the 13 day of July, 1999.

Attest: [Signature]
Clerk of the Board of County Commissioners

COLONIAL REALTY PROPERTIES LIMITED PARTNERSHIP

By: Colonial Properties Trust, its general partner

By: [Signature]

Title: Executive Vice-P

Aimee' B. Richard
-Witness (Signature)

Aimee' B. Richard
Witness (Print Name)

[Signature]
Witness (Signature)

Melanie Mann
Witness (Print Name)

STATE OF FLORIDA

COUNTY OF Orange

The foregoing instrument was acknowledged and subscribed before me by FRED C. EDWARDS, JR. on this 29th day of July, 1999, and who is personally known to me and _____ as identification.

Michael P. McMahon

Notary Public, State of Florida

(Print, Type or Stamp Commissioned Name of Notary Public)



Michael P McMahon
My Commission CC736745
Expires June 5, 2002

STATE OF Alabama

COUNTY OF Jefferson

The foregoing instrument was acknowledged and subscribed before me by Charles A. McGeehee, as Executive V.P., of Colonial Properties Trust, General Partner of COLONIAL REALTY LIMITED PARTNERSHIP, on this 2nd day of Aug, 1999, and who is personally known to me ~~or who has produced~~ _____ as identification.

Patricia C. Bradford
Notary Public, State of Alabama
Patricia C. Bradford

(Print, Type or Stamp Commissioned Name of Notary Public)

Shutts & Bowen/Colonial Grand
Suburban Estates to Planned Development

RECOMMENDATIONS	
<p>BOARD OF COUNTY COMMISSIONERS</p> <p>SEPTEMBER 22, 1998</p>	<p>The Board of County Commissioners voted to continue the amendment and rezoning to their October 13, 1998, meeting.</p>
<p>BOARD OF COUNTY COMMISSIONERS</p> <p>OCTOBER 13, 1998</p>	<p>Plan Amendment:: The Board of County Commissioners voted 4-1 to adopt Planned Development land use with staff findings.</p> <p>Rezone: In a related action, the Board of County Commissioners voted to adopt PUD (Planned Unit Development) zoning on the site, subject to:</p> <ol style="list-style-type: none"> 1. First tier of buildings along the lakefront and along the north buffer to be a maximum of two (2) stories. Buildings on the remainder of the site may be three (3) stories, with a maximum height of 35'. 2. No parking areas to be located adjacent to the lake. 3. Apartment buildings to be similar in scale and architecture as the existing buildings in Phase I. 4. The applicant to maintain a 200' buffer along the north property line. There shall be no buildings or other structures, parking, or roadways within the buffer; however, stormwater retention ponds may be located within the south 150' of the buffer. Within the north 50' of the buffer, the applicant shall provide a 50-foot wide strip of vegetative plantings. The applicant shall construct a 6-foot high brick wall on a 2' high berm (or a 5-foot brick wall on a 3' high berm), to be located 15' from the north property line. Design of the brick wall shall be consistent with the design of the existing HIBC wall to the east, and the required wall shall connect to the existing HIBC wall. Plantings within the 50' strip south of the wall to be a minimum of two staggered rows of canopy trees at 25' intervals, with at least two tree species utilized. Plantings north of the wall to consist of two staggered rows of trees. Applicant to provide additional tree plantings throughout the buffer, with the exception of stormwater pond sites. Applicant to be responsible for maintenance of the wall and plantings.

Shutts & Bowen/Colonial Grand
Suburban Estates to Planned Development

RECOMMENDATIONS

BOARD OF COUNTY
COMMISSIONERS

OCTOBER 13, 1998

5. There shall be no access to the First tier of buildings along the lakefront and along the north buffer to be a north via Banana Lake Road.
6. Applicant to retain existing pine trees on the "peninsula" area to the greatest extent practical. Where necessary, supplemental plantings of canopy and understory trees will be required to "break up" the view of the complex from neighboring properties. Supplemental plantings to be determined during site plan review.
7. Applicant to preserve existing specimen trees to the greatest extent practical. Where necessary, replacement tree plantings in accordance with County arbor regulations will be required. Replacement tree requirements to be determined during site plan review.
8. Site lighting to be cut-off/shoebox type, with a maximum height of 20', including fixtures. Lighting to be located no closer than 50' to the north property line or lakefront, and footcandles at the north and west property lines may not exceed 0.5.
9. Applicant may provide boardwalks and other passive amenities along the lakefront. However, no personal watercraft or boats to be permitted.
10. Minimum buffer along the lake to be 50' in width, with an additional 20' building setback. Only minor recreational uses (boardwalks, picnic tables, and similar uses) are permitted within the buffer.

Shutts & Bowen/Colonial Grand Suburban Estates to Planned Development		
RECOMMENDATIONS		
BOARD OF COUNTY COMMISSIONERS OCTOBER 13, 1998	<ol style="list-style-type: none"> <li data-bbox="727 470 1513 566">11. Applicant to investigate means to cooperatively improve and maintain Island Lake, including partnerships with HOAs within Heathrow or other applicable entities. <li data-bbox="727 597 1513 810">12. In Phase I (existing apartments), applicant to provide additional canopy tree plantings to enhance buffering along the lake. Plantings to consist of scattered fast-growing canopy trees of at least two (2) species. Majority of the plantings to be utilized at the three apartment buildings along the lake and closest to the satellite dish location. <li data-bbox="727 842 1513 1023">13. In Phase I (existing apartments), applicant to provide additional buffering at the satellite dish location. Plantings on the side facing the lake to consist of a hedge and staggered row of understory trees. Alternatively, the satellite dish installation may be relocated interior to the site. 	



**ENGINEERING &
ENVIRONMENTAL
DESIGN, INC.**

Engineers, Environmental & Planning Consultants

December 19, 2002

12-20-02 A08:29 N

Mr. Kent Cichon
Seminole County Planning and Development Department
1101 East First Street
Sanford, Florida 32771-1468
Tel No.: 407.665.7126
Fax No.: 407.665.7956

Banana Lake Large Scale Land Use Amendment and Rezoning
EED Job No.: 2002.033

Dear Mr. Cichon:

This letter is to request a thirty (30) day extension from the January 8, 2003 Planning & Zoning Board meeting to the February Planning & Zoning Board Meeting, for the above referenced project.

It is my understanding that Ken Wright and Don Fischer have discussed this extension and that the thirty (30) day extension can be granted and allow the project to be transmitted to Department of Community Affairs for review as part of the spring submittal. This delay will allow the time necessary to fully analyze Banana Lake Road and complete an agreement with your department concerning what improvements are required.

Your earliest review and response to this request is greatly appreciated.

Very truly yours,

ENGINEERING & ENVIRONMENTAL DESIGN, INC.

Larry T. Ray, P.E.

Jim Fant, (Fax No.: 407.425.6841)
Ken Wright, (Fax No.: 407.425.8316)
Don Curotto, (Fax No.: 407.422.8262)
Richard E. Dunn, P.E., EED

\\Server1\Firm\Com Correspondence\1219-cto\ee\EXTENSION-121702.doc



February 6, 2003

Mr. Mahmoud Najda, P.E.
Seminole County Government
1101 East First Street, 2nd Floor West Wing
Sanford, Florida 32771
Tel No.: 407.665.7341
Fax No.: 407.665.7956

RE: Banana Lake Road Improvements / Banana Lake PD
 Seminole County Project #21-23000005
 EED Job No.: 2002.033

Dear Mr. Najda:

As requested, we have performed a preliminary pavement evaluation (See attached Yovaish Engineering Report) and roadway improvement report for Banana Lake Road from its intersection with SR 46A south to the southern limits of the Edwards Property. The intent is to upgrade this road to current Seminole County Standards, with the exception of the width of the roadway which will be widened to 22' in lieu of 24' wide county standard and that no stormwater collection system will be constructed.

The northern portion of the road from Station 11+00 to Station 27+86± will receive an overlayment of 1" type SIII asphaltic concrete. This portion of the roadway is approximately 22' wide and will not be widened any further (see Sketch 1).

The center portion of the roadway from Station 27+86± to Station 30+87 in the vicinity of the old sinkhole will be completely removed and reconstructed unless further studies indicate this is not necessary. The roadway centerline radius in this area is 110'. Each lane of the roadway from PC to PT of this curve will be increased by 3' in accordance with County Standards. The width of these lanes will transition from 14' lanes to 11' lanes at the proceeding PC's or PT's of the adjacent curves (See Sketch 2).

The southern portion of the roadway from Station 30+87± to Station 47+31 will be widened from its existing 17 to 21' width to a constant 22' width. It is anticipated that all widening will occur on the eastern side of the existing road to avoid disturbing any of the trees along this portion of the road. This entire section of road will receive a minimum 1' thick overlayment with Type SIII asphaltic concrete and the crown of the road shifted to the center of the widened road (see Sketch 3).

Guardrail will be installed where required for safety reasons and as mentioned earlier no trees will be removed except where required for safety reasons.

The above mentioned stations for the various roadway improvements are approximate and will be adjusted based on the results of a complete geotechnical evaluation and when final engineering documents are prepared.

If you have any question, please let me know.

Very truly yours,

ENGINEERING & ENVIRONMENTAL DESIGN, INC.



Richard E. Dunn, P.E.
Project Manager

cc. Kent Cichon, (Fax No.: 407.665.7956)
Jim Fant (Fax No.: 407.425.8276)
Ken Wright, Esq. (Fax No.: 407.425.8316)
Larry T. Ray, P.E., EED



TABLE OF CONTENTS

LIST OF ATTACHMENTS:

- ATTACHMENT 1: SKETCH 1: BANANA LAKE ROAD STATION 11+00 TO STATION 27+85.92**
- ATTACHMENT 2: SKETCH 2: BANANA LAKE ROAD STATION 27+85.92 TO STATION 30+87.94**
- ATTACHMENT 3: SKETCH 3: BANANA LAKE ROAD STATION 27+85.92 TO STATION 47+31**
- ATTACHMENT 4: YOVAISH ENGINEERING SCIENCES: EVALUATION OF THE EXISTING PAVEMENT SECTION**
- ATTACHMENT 5: BANANA LAKE ROAD PLAN**
- ATTACHMENT 6: BANANA LAKE ROAD CERTIFIED SURVEY**

ATTACHMENT 1:

**SKETCH 1: BANANA LAKE ROAD
STATION 11+00 TO STATION 27+85.92**

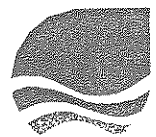

Hi:\proj\2002033\dwg\EXHIBITS\SK1.dwg 02/04/2003 01:21:23 PM PM EST

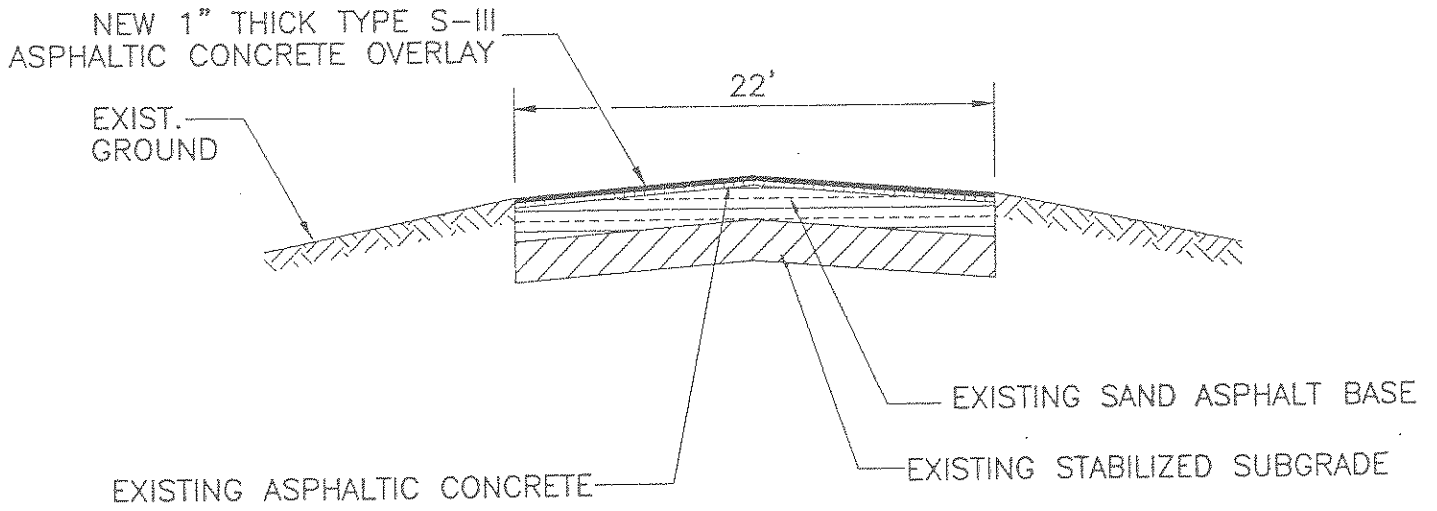

BANANA LAKE ROAD

STA. 11+00 TO STA. 27+85.92

N.T.S.



**ENGINEERING &
ENVIRONMENTAL
DESIGN, INC.**

Engineers, Environmental and Planning Consultants

122 E. COLONIAL DRIVE, SUITE 200
ORLANDO, FLORIDA 32801

OFF: (407) 650-0006
FAX: (407) 646-8338

BANANA LAKE ROAD

SKETCH 1

ATTACHMENT 2:

**SKETCH 2: BANANA LAKE ROAD
STATION 27+85.92 TO STATION 30+87.94**



H:\proj\2002033\dwg\EXHIBITS\SK2.dwg 02/04/2003 01:23:13 PM PM EST

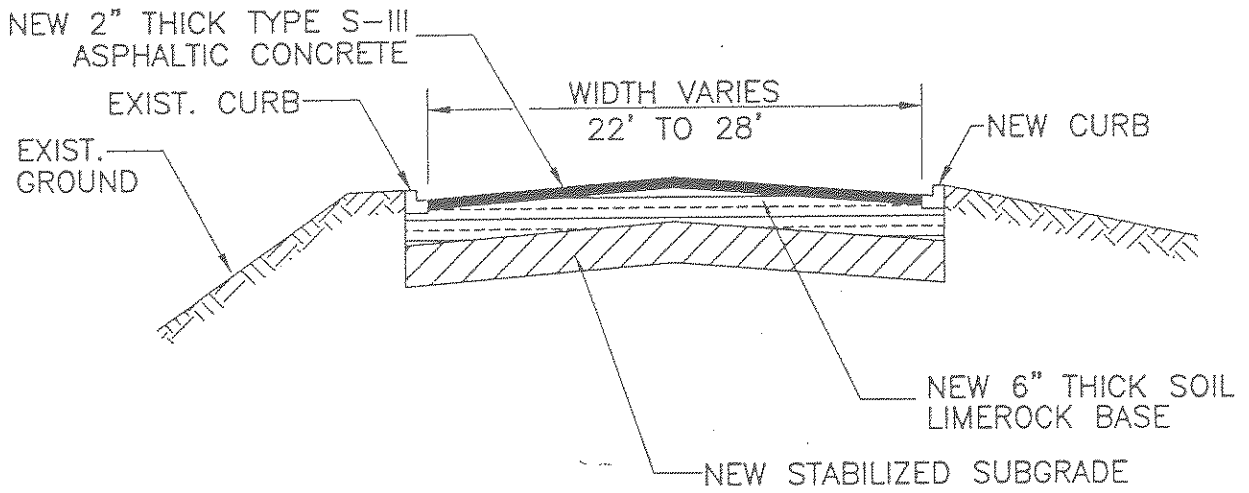

BANANA LAKE ROAD

STA. 27+85.92 TO STA. 30+87.94

N.T.S.



**ENGINEERING &
ENVIRONMENTAL
DESIGN, INC.**

Engineers, Environmental and Planning Consultants

122 E. COLONIAL DRIVE, SUITE 200
ORLANDO, FLORIDA 32801

TEL: (407) 850-0006
FAX: (407) 648-6336

BANANA LAKE ROAD

SKETCH 2

ATTACHMENT 3:

**SKETCH 3: BANANA LAKE ROAD
STATION 30+87.94 TO STATION 47+31**



H:\proj\2002033\dwg\EXHIBITS\SK3.dwg 02/04/2003 01:25:36 PM EST

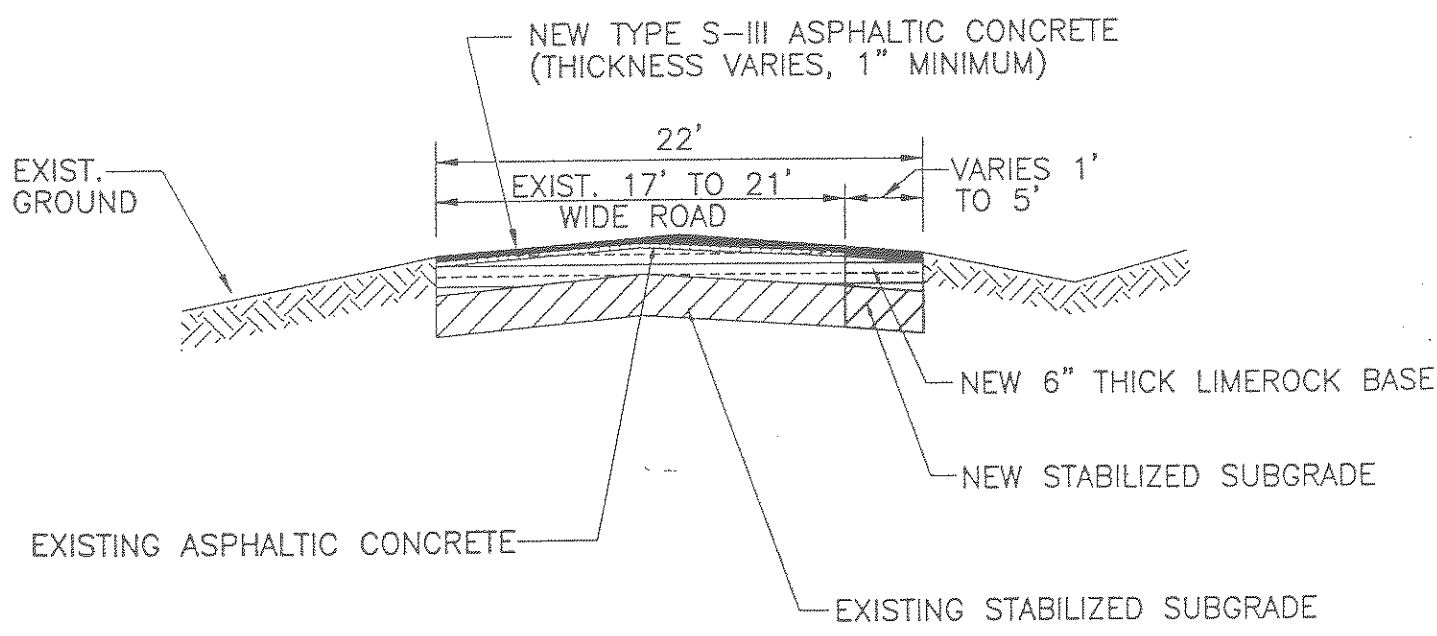

BANANA LAKE ROAD

STA. 30+87.94 TO STA. 47+31

N.T.S.

NOTE:

1. PAVEMENT TO BE WIDENED TO EAST.
2. TREES WILL ONLY BE REMOVED TO ACCOMMODATE WIDENING.

ATTACHMENT 4:

**YOVAISH ENGINEERING SCIENCES:
EVALUATION OF THE EXISTING
PAVEMENT SECTION**



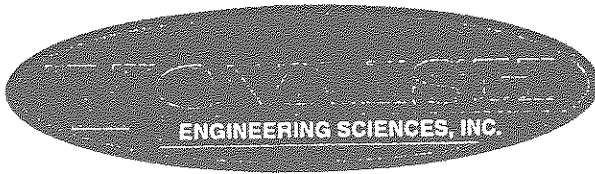

Consulting Engineers in the Earth Sciences, Geotechnology,
Hydrogeology and Construction Materials Testing

January 27, 2003

Brooksville Development Corporation
401 W. Colonial Drive, Suite 7
Orlando, Florida 32804

Attention: Mr. Jim Fant

Subject: Evaluation of the Existing Pavement Section, Banana Lake Road, Seminole
County, Florida (PN 02-E0414.04)

Dear Mr. Fant:

As requested, we have performed a pavement evaluation at the subject roadway. The purpose of our study was to provide a general evaluation as to the composition of the existing pavement sections. Recommendations, if required, for improving the existing pavement section to meet the pavement structural number (SN) provided by the Residential and Local Streets for Seminole County were to be provided. In addition, and as requested by the Seminole County staff, we performed a preliminary evaluation of the potential cause(s) of longitudinal pavement cracks noted along portions of the roadway alignment. The following report describes the field program and provides our evaluations.

1.0 PAVEMENT CONDITION SURVEY

Banana Lake Road is located approximately 3/4 mile west of Interstate 4 and extends approximately 4850 linear south from County Road 46A. The portion of the roadway under study is depicted on Figure 1 and the preliminary plans prepared by Engineering and Environmental Design, Inc. The southern portion of the roadway was reported to have been recently paved by the Seminole County roadway department.

A visual pavement condition survey was performed by representatives of Yovaish Engineering Sciences, Inc., on December 3, 2002. Based upon visual inspections, the paved roadway areas comprise asphaltic concrete with an open drainage system. The surface of the pavement is moderately smooth. In general, the pavement appears in a good condition. As an exception, longitudinal cracks were noted along portions of the roadway. Specifically, longitudinal cracks varying from approximately 1/4 to as much as 1/2 inch in width were noted from approximately

Station 13+00 to Station 15+50 and approximately Station 27+00 to Station 31+00 (see the hatched areas depicted on Figure 1).

2.0 PAVEMENT AND SUBGRADE SOIL EVALUATION

Representatives of Yovaish Engineering Sciences, Inc. performed coring operations. The coring operations consisted of advancing a "diamond - tipped " 4-inch diameter core barrel through the existing asphaltic concrete and base course. Thereafter, our representatives explored the subgrade soils by performing auger borings to depths of 2.5 feet below the top of pavement. Core specimens of the pavement were obtained at a total of thirteen (13) locations. The core locations, selected by Yovaish Engineering Sciences, Inc., were performed at a spacing of approximately 500 feet on center. Additional core samples (5 locations) were collected as determined by the Seminole County Staff. The location of each core is depicted on the site Location Plan of Figure 1, attached.

In summary, the results of our investigation indicated that the existing pavement consisted of an asphaltic concrete wearing surface underlain by a Soil Cement base or Sand Asphalt Base. In addition, the asphaltic concrete appears to comprise as many as three (3) layers, indicating that the pavement has been resurfaced/overlay. The dates of the resurfacing(s) are not known. Based upon visual inspection, the asphaltic concrete consisted of FDOT Type S and Type III. In addition, composite samples of the subgrade soils encountered were subjected to Florida Bearing Value (FBV) testing. The measured FBV values varied from 90 to 205 psi. The specific data associated with the thickness of pavement layer(s) encountered are presented in Table 1, attached.

3.0 EVALUATIONS AND CONCLUSIONS

3.1 Pavement Section Evaluation

Our evaluation of the structural number (SN) provided by the Seminole County Local and Residential Streets is presented on Attachment A. Our evaluations for the structural numbers (SN) provided by the existing roadway sections are presented on Table 2, attached. Based upon the results of our analyses and with the exception of core location C-8, the structural number of the existing pavement section may be improved to meet the minimum county standard section by adding a 1 inch overlay of Type S-III asphaltic concrete. The location of core C-8 will require adding 2 inches of Type S-III asphaltic concrete.

3.2 Cracked Asphaltic Wearing Surface

Longitudinal cracks varying from approximately 1/4 to as much as 1/2 inch in width were noted from approximately Station 13+00 to Station 15+50 and approximately Station 27+00 to Station 31+00 (see the hatched areas depicted on Figure 1). Based upon review of the USGS Quadrangle Map and the roadway survey data provided to us, the affected portions of the roadway are located adjacent to natural low lying areas. The top of bank elevation of the low lying area near Station 13+00 is approximately +59 feet, while the top of bank elevation of the low lying area near Station 27+00 is approximately +65 feet. Based upon our considerable past experience and knowledge of investigating such features within the region of this roadway, the natural low lying areas are the result of an ancient sinkhole(s). The cracks noted within the affected portions of the roadway are, in our preliminary opinion, the result of long term settlement of fill placed with the limits of the former low lying areas (which may contain compressible organic soils). It is instructive to note that the settlement and/or cracks do not appear to significantly affect the use of the roadway. Furthermore, the rate of long term settlement has decreased since the initial placement and will continue to decrease with time. In addition, the relatively steep embankment slope(s) noted near Station 27+00 could have contributed to part of the settlement in that affected area.

In order to allow for more uniform future settlement that may occur and help minimize future cracking of the pavement overlay, it is our opinion that geofabric may be placed within the roadway subgrade below the affected pavement areas. In addition, portions of the relatively steep embankment slopes may be flattened and/or reinforced with geogrid. A conceptual cross-section of the placement of the geogrid and/or geofabric below the affected portions of the roadway area presented on Plate 1, attached. In addition, we recommend that if the roadway must be widened near the affected areas, the additional pavement should be constructed on the east side of the roadway. Once the west edge of the proposed improvements to the roadway and roadway shoulder have been determined and deep test borings are performed, more specific recommendations for geogrid and/or geofabric placement may be provided.

4.0 CLOSURE

It has been a pleasure performing our engineering services for you and we trust that the information provided herein satisfies your immediate needs. If you have questions regarding the contents of this report, or if we can be of any further assistance, please do not hesitate to contact our office.

Sincerely,

Yovaish Engineering Sciences, Inc.

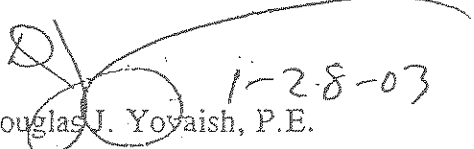
1-28-03
Douglas J. Yovaish, P.E.
President
Florida Registration No. 52247

DJY/law H:\yes\lgeol\2002\02-E0414.04 Banana Lake Road\pavement evaluation.wpd

Enclosures: Figure 1
Tables 1 and 2
Attachment A
Plate 1

Table 1. Summary of Pavement Layer(s) Encountered.

Core Location	Asphaltic Concrete Type/ Layer Thickness (inches)	Asphaltic Concrete Type/ Layer Thickness (inches)	Asphaltic Concrete Type/ Layer Thickness (inches)	Base Type/Thickness (inches) 1.)	Comments
C-1	(S)/1-3/8	(III)/1-3/8	na	(SAB)2-1/2	
C-2	(S)/1-1/8	(S)/5/8	(III)/3/4	(SAB)4-1/4	
C-3	(III)/3/4	(III)/1/2	na	(SAB)5-3/8	
C-4	(S)/5/8	(S)/5/8	(III)/3/4	(SAB)4	
C-5	(III)/5/8	(III)/1-1/8	(III)/3/4	(SAB)3-1/2	
C-6	(III)/1-1/8	(III)/1-1/4	na	(SAB)3	core cracked
C-7	(III)/7/8	(III)/5/8	na	(SAB)4-3/4	
C-8	(III)/3/8	na	na	(SAB)4-1/4	asphaltic surface not typical of general roadway sections
C-9	(S)/2-1/8	na	na	(LR)7	
C-10	(S)/2-1/4	na	na	(LR)5	
C-11	(S)/2	na	na	(LR)7	
C-12	(S)/1	(S)/1-3/8	na	(LR)4	
C-13	(S)/1-1/8	(S)/1-1/4	na	(LR)6	

Notes: S= FDOT Type S Asphaltic Concrete
 III= FDOT Type III Asphaltic Concrete
 SAB = Sand Asphalt Base
 LR= Limerock

Table 2. Summary of estimated pavement structural numbers (SN) provided by the encountered pavement layers.

Core Location	Wearing Surface				Base Course				10 inch Stabilized Subgrade	Total Structural Number (SN)	Additional Structural Value Required	Required Asphalt Overlay
	Asphaltic Concrete Type S (inch)	Layer Structural Number (SN)	Asphaltic Concrete Type III (inch)	Layer Structural Number (SN)	Limerock Base (inch)	Layer Structural Number (SN)	Sand Asphalt Base (inch)	Layer Structural Number (SN)				
C-1	1 3/8	0.594	1 3/8	0.419	-	-	2 1/2	0.380	0.510	1.903	0.167	3/8
C-2	1 3/4	0.756	3/4	0.229	-	-	4 1/4	0.646	0.510	2.141	0.000	0
C-3	-	-	1 1/4	0.381	-	-	5 3/8	0.817	0.510	1.708	0.362	7/8
C-4	1 1/4	0.540	3/4	0.229	-	-	4	0.608	0.510	1.887	0.183	3/8
C-5	-	-	2 1/2	0.763	-	-	3 1/2	0.532	0.510	1.805	0.265	5/8
C-6	-	-	2 3/8	0.724	-	-	3	0.456	0.510	1.690	0.380	7/8
C-7	-	-	1 1/2	0.458	-	-	4 3/4	0.722	0.510	1.690	0.380	7/8
C-8	-	-	3/8	0.114	-	-	4 1/4	0.646	0.510	1.270	0.800	1 7/8
C-9	2 1/8	0.918	-	-	7	1.246	-	-	0.510	2.674	0.000	na
C-10	2 1/4	0.972	-	-	5	0.890	-	-	0.510	2.372	0.000	na
C-11	2	0.864	-	-	7	1.246	-	-	0.510	2.620	0.000	na
C-12	2 3/8	1.026	-	-	4	0.712	-	-	0.510	2.248	0.000	na
C-13	2 3/8	1.026	-	-	6	1.068	-	-	0.510	2.604	0.000	na



Note: Asphalt Layer Thickness at Core C-8 not consistent with remaining roadway. Milling and 2 inch overlay required.
The horizontal limits for milling may be determined by performing additional cores and/or at the time of construction.

Per the FDOT Flexible Pavement Design Manual the Structural Coefficients for the Different Pavement Layers are as follows:

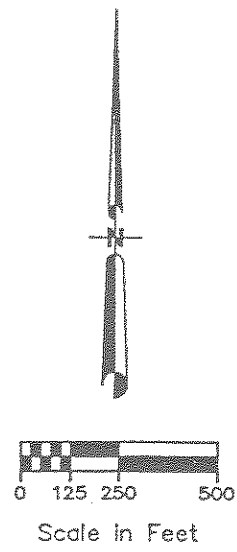
Type S Asphaltic Concrete	0.432 per inch
Type III Asphaltic Concrete	0.305 per inch
Limerock	0.178 per inch
Soil Cement	0.152 per inch
Stabilized Subgrade	0.051 per inch



LEGEND

- 
 PAVEMENT CORE LOCATION (DETERMINED BY YOVAISH ENGINEERING SCIENCES, INC.)
- 
 PAVEMENT CORE LOCATION (DETERMINED BY SEMINOLE COUNTY STAFF)
- 
 HATCHING DEPICTS APPROXIMATE LOCATION OF REPORTED LONGITUDINAL CRACKS IN PAVEMENT SURFACE

LOCATION PLAN

EVALUATION FOR EXISTING PAVEMENT

BANANA LAKE ROAD

SEMINOLE COUNTY, FLORIDA

DRAWN : CJC	SCALE : NOTED	JOB NO. : 02-E0414.04
APPROVED : DJY	DATE : 12/12/02	FIGURE: 1

LOCPLAN.DWG

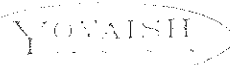

Yovaish Engineering & Science, Inc.
 10000 N.W. 15th Ave., Suite 100
 Fort Lauderdale, Florida 33331
 Phone: (954) 571-1111
 Fax: (954) 571-1112
 Website: www.yovaish.com

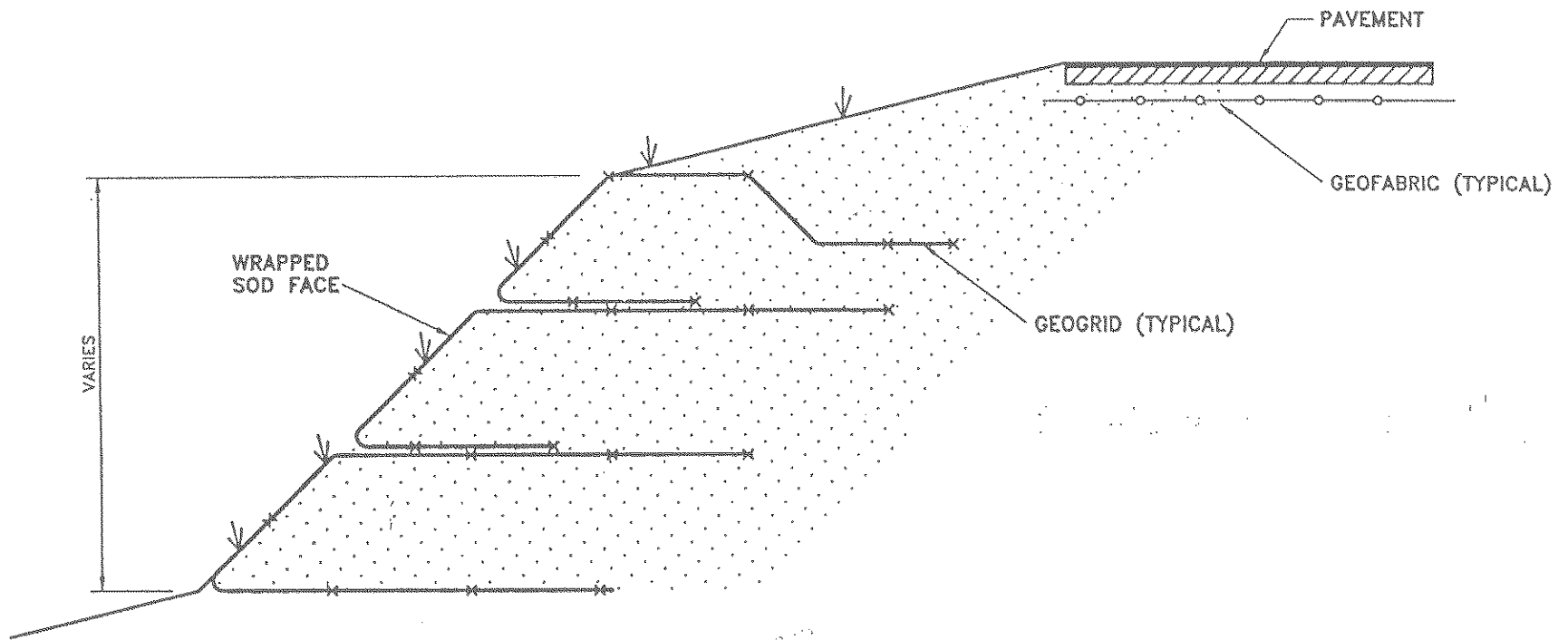

CONCEPTUAL CROSS-SECTION

GEOGRID REINFORCED EARTHEN SLOPE AND/OR GEOFABRIC REINFORCED SUBGRADE
 PRELIMINARY ESTIMATED LOCATIONS: STATION 13+00 TO STATION 15+50 AND STATION 27+00 TO 31+00

EVALUATION FOR EXISTING PAVEMENT		
BANANA LAKE ROAD		
SEMINOLE COUNTY, FLORIDA		
DRAWN : CJC	SCALE : NOTED	JOB NO. : 02-E0414.04
APPROVED : D.V.	DATE : 01/27/07	PLATE:

ATTACHMENT A
Pavement Structural Numbers (SN)
Provided by Seminole County for Residential and Local Streets
Banana Lake Road Study
Seminole County, Florida
(PN 02-E0414.04)

The pavement section for the Residential and Local Streets for Seminole County may comprises: 1-1/2 inches of Type S asphaltic concrete; 6 inches limerock base; and 10 inches of stabilized subgrade (Stabilized to minimum FBV equal to 75 psi). The resulting structural number (SN) provided by the pavement section may be determined as shown below:

•	1-1/2 inches Asphaltic Concrete	1-1/2 x 0.432 =	0.648
•	10 inches stabilized subgrade	10 x 0.051 =	0.510
•	6 inches soil cement	6 x 0.152 =	<u>0.912</u>
		SN =	2.07

ATTACHMENT 5:
BANANA LAKE ROAD PLAN



ATTACHMENT 6:
BANANA LAKE ROAD CERTIFIED SURVEY



SPECIFIC PURPOSE TOPOGRAPHIC SURVEY

THIS IS NOT A BOUNDARY SURVEY

KEY SHEET - LOCATION MAP

BANANA LAKE ROAD

Legend of Symbols & Abbreviations:

1/4" = 1' OTHER ONE EIGHTH	1/8" = 1' 1/2" POLE	ALM-ALTERNATE LAND SURV.	BN-BOUNDARY
1/8" = 1' 1/2" OTHER ONE EIGHTH	2" = 2' 6" OTHER ONE EIGHTH	ALM-ALTERNATE LAND SURV.	BN-BOUNDARY
1/16" = 1/2" OTHER ONE SIXTEEN	3" = 3' 6" OTHER ONE EIGHTH	ALM-ALTERNATE LAND SURV.	BN-BOUNDARY
1/32" = 1/4" OTHER ONE THIRTY TWO	4" = 4' 6" OTHER ONE EIGHTH	ALM-ALTERNATE LAND SURV.	BN-BOUNDARY
1/64" = 1/8" OTHER ONE SIXTY FOUR	5" = 5' 6" OTHER ONE EIGHTH	ALM-ALTERNATE LAND SURV.	BN-BOUNDARY
1/128" = 1/16" OTHER ONE HUNDRED TWENTY EIGHT	6" = 6' 6" OTHER ONE EIGHTH	ALM-ALTERNATE LAND SURV.	BN-BOUNDARY
1/256" = 1/32" OTHER ONE FIFTY TWO	7" = 7' 6" OTHER ONE EIGHTH	ALM-ALTERNATE LAND SURV.	BN-BOUNDARY
1/512" = 1/64" OTHER ONE TWENTY SIX	8" = 8' 6" OTHER ONE EIGHTH	ALM-ALTERNATE LAND SURV.	BN-BOUNDARY
1/1024" = 1/8192" OTHER ONE THIRTY TWO	9" = 9' 6" OTHER ONE EIGHTH	ALM-ALTERNATE LAND SURV.	BN-BOUNDARY
1/2048" = 1/16384" OTHER ONE THIRTY TWO	10" = 10' 6" OTHER ONE EIGHTH	ALM-ALTERNATE LAND SURV.	BN-BOUNDARY
1/4096" = 1/32768" OTHER ONE THIRTY TWO	11" = 11' 6" OTHER ONE EIGHTH	ALM-ALTERNATE LAND SURV.	BN-BOUNDARY
1/8192" = 1/65536" OTHER ONE THIRTY TWO	12" = 12' 6" OTHER ONE EIGHTH	ALM-ALTERNATE LAND SURV.	BN-BOUNDARY
1/16384" = 1/131072" OTHER ONE THIRTY TWO	13" = 13' 6" OTHER ONE EIGHTH	ALM-ALTERNATE LAND SURV.	BN-BOUNDARY
1/32768" = 1/262144" OTHER ONE THIRTY TWO	14" = 14' 6" OTHER ONE EIGHTH	ALM-ALTERNATE LAND SURV.	BN-BOUNDARY
1/65536" = 1/524288" OTHER ONE THIRTY TWO	15" = 15' 6" OTHER ONE EIGHTH	ALM-ALTERNATE LAND SURV.	BN-BOUNDARY
1/131072" = 1/1048576" OTHER ONE THIRTY TWO	16" = 16' 6" OTHER ONE EIGHTH	ALM-ALTERNATE LAND SURV.	BN-BOUNDARY
1/262144" = 1/2097152" OTHER ONE THIRTY TWO	17" = 17' 6" OTHER ONE EIGHTH	ALM-ALTERNATE LAND SURV.	BN-BOUNDARY
1/524288" = 1/4194304" OTHER ONE THIRTY TWO	18" = 18' 6" OTHER ONE EIGHTH	ALM-ALTERNATE LAND SURV.	BN-BOUNDARY
1/1048576" = 1/8388608" OTHER ONE THIRTY TWO	19" = 19' 6" OTHER ONE EIGHTH	ALM-ALTERNATE LAND SURV.	BN-BOUNDARY
1/2097152" = 1/16777216" OTHER ONE THIRTY TWO	20" = 20' 6" OTHER ONE EIGHTH	ALM-ALTERNATE LAND SURV.	BN-BOUNDARY
1/4194304" = 1/33554432" OTHER ONE THIRTY TWO	21" = 21' 6" OTHER ONE EIGHTH	ALM-ALTERNATE LAND SURV.	BN-BOUNDARY
1/8388608" = 1/67108864" OTHER ONE THIRTY TWO	22" = 22' 6" OTHER ONE EIGHTH	ALM-ALTERNATE LAND SURV.	BN-BOUNDARY
1/16777216" = 1/134217728" OTHER ONE THIRTY TWO	23" = 23' 6" OTHER ONE EIGHTH	ALM-ALTERNATE LAND SURV.	BN-BOUNDARY
1/33554432" = 1/268435456" OTHER ONE THIRTY TWO	24" = 24' 6" OTHER ONE EIGHTH	ALM-ALTERNATE LAND SURV.	BN-BOUNDARY
1/67108864" = 1/536870912" OTHER ONE THIRTY TWO	25" = 25' 6" OTHER ONE EIGHTH	ALM-ALTERNATE LAND SURV.	BN-BOUNDARY
1/134217728" = 1/1073741824" OTHER ONE THIRTY TWO	26" = 26' 6" OTHER ONE EIGHTH	ALM-ALTERNATE LAND SURV.	BN-BOUNDARY
1/268435456" = 1/2147483648" OTHER ONE THIRTY TWO	27" = 27' 6" OTHER ONE EIGHTH	ALM-ALTERNATE LAND SURV.	BN-BOUNDARY
1/536870912" = 1/4294967296" OTHER ONE THIRTY TWO	28" = 28' 6" OTHER ONE EIGHTH	ALM-ALTERNATE LAND SURV.	BN-BOUNDARY
1/1073741824" = 1/8589934592" OTHER ONE THIRTY TWO	29" = 29' 6" OTHER ONE EIGHTH	ALM-ALTERNATE LAND SURV.	BN-BOUNDARY
1/2147483648" = 1/17179869184" OTHER ONE THIRTY TWO	30" = 30' 6" OTHER ONE EIGHTH	ALM-ALTERNATE LAND SURV.	BN-BOUNDARY
1/4294967296" = 1/34359738368" OTHER ONE THIRTY TWO	31" = 31' 6" OTHER ONE EIGHTH	ALM-ALTERNATE LAND SURV.	BN-BOUNDARY
1/8589934592" = 1/68719476736" OTHER ONE THIRTY TWO	32" = 32' 6" OTHER ONE EIGHTH	ALM-ALTERNATE LAND SURV.	BN-BOUNDARY
1/17179869184" = 1/137438953472" OTHER ONE THIRTY TWO	33" = 33' 6" OTHER ONE EIGHTH	ALM-ALTERNATE LAND SURV.	BN-BOUNDARY
1/34359738368" = 1/27487790752" OTHER ONE THIRTY TWO	34" = 34' 6" OTHER ONE EIGHTH	ALM-ALTERNATE LAND SURV.	BN-BOUNDARY
1/68719476736" = 1/54975581504" OTHER ONE THIRTY TWO	35" = 35' 6" OTHER ONE EIGHTH	ALM-ALTERNATE LAND SURV.	BN-BOUNDARY
1/137438953472" = 1/109951163008" OTHER ONE THIRTY TWO	36" = 36' 6" OTHER ONE EIGHTH	ALM-ALTERNATE LAND SURV.	BN-BOUNDARY
1/27487790752" = 1/219902326016" OTHER ONE THIRTY TWO	37" = 37' 6" OTHER ONE EIGHTH	ALM-ALTERNATE LAND SURV.	BN-BOUNDARY
1/54975581504" = 1/439804652032" OTHER ONE THIRTY TWO	38" = 38' 6" OTHER ONE EIGHTH	ALM-ALTERNATE LAND SURV.	BN-BOUNDARY
1/109951163008" = 1/879609304064" OTHER ONE THIRTY TWO	39" = 39' 6" OTHER ONE EIGHTH	ALM-ALTERNATE LAND SURV.	BN-BOUNDARY
1/219902326016" = 1/1759218608128" OTHER ONE THIRTY TWO	40" = 40' 6" OTHER ONE EIGHTH	ALM-ALTERNATE LAND SURV.	BN-BOUNDARY
1/439804652032" = 1/3518437216256" OTHER ONE THIRTY TWO	41" = 41' 6" OTHER ONE EIGHTH	ALM-ALTERNATE LAND SURV.	BN-BOUNDARY
1/879609304064" = 1/7036874432512" OTHER ONE THIRTY TWO	42" = 42' 6" OTHER ONE EIGHTH	ALM-ALTERNATE LAND SURV.	BN-BOUNDARY
1/1759218608128" = 1/14073748865024" OTHER ONE THIRTY TWO	43" = 43' 6" OTHER ONE EIGHTH	ALM-ALTERNATE LAND SURV.	BN-BOUNDARY
1/3518437216256" = 1/28147497730048" OTHER ONE THIRTY TWO	44" = 44' 6" OTHER ONE EIGHTH	ALM-ALTERNATE LAND SURV.	BN-BOUNDARY
1/7036874432512" = 1/56294995460096" OTHER ONE THIRTY TWO	45" = 45' 6" OTHER ONE EIGHTH	ALM-ALTERNATE LAND SURV.	BN-BOUNDARY
1/14073748865024" = 1/112589990920192" OTHER ONE THIRTY TWO	46" = 46' 6" OTHER ONE EIGHTH	ALM-ALTERNATE LAND SURV.	BN-BOUNDARY
1/28147497730048" = 1/225179981840384" OTHER ONE THIRTY TWO	47" = 47' 6" OTHER ONE EIGHTH	ALM-ALTERNATE LAND SURV.	BN-BOUNDARY
1/56294995460096" = 1/450359963680768" OTHER ONE THIRTY TWO	48" = 48' 6" OTHER ONE EIGHTH	ALM-ALTERNATE LAND SURV.	BN-BOUNDARY
1/112589990920192" = 1/900719927361536" OTHER ONE THIRTY TWO	49" = 49' 6" OTHER ONE EIGHTH	ALM-ALTERNATE LAND SURV.	BN-BOUNDARY
1/225179981840384" = 1/1803539854723072" OTHER ONE THIRTY TWO	50" = 50' 6" OTHER ONE EIGHTH	ALM-ALTERNATE LAND SURV.	BN-BOUNDARY
1/450359963680768" = 1/3607079709446144" OTHER ONE THIRTY TWO	51" = 51' 6" OTHER ONE EIGHTH	ALM-ALTERNATE LAND SURV.	BN-BOUNDARY
1/900719927361536" = 1/7214159418892288" OTHER ONE THIRTY TWO	52" = 52' 6" OTHER ONE EIGHTH	ALM-ALTERNATE LAND SURV.	BN-BOUNDARY
1/1803539854723072" = 1/14428318837784576" OTHER ONE THIRTY TWO	53" = 53' 6" OTHER ONE EIGHTH	ALM-ALTERNATE LAND SURV.	BN-BOUNDARY
1/3607079709446144" = 1/28856637675569152" OTHER ONE THIRTY TWO	54" = 54' 6" OTHER ONE EIGHTH	ALM-ALTERNATE LAND SURV.	BN-BOUNDARY
1/7214159418892288" = 1/57713275351138304" OTHER ONE THIRTY TWO	55" = 55' 6" OTHER ONE EIGHTH	ALM-ALTERNATE LAND SURV.	BN-BOUNDARY
1/14428318837784576" = 1/115426550702276608" OTHER ONE THIRTY TWO	56" = 56' 6" OTHER ONE EIGHTH	ALM-ALTERNATE LAND SURV.	BN-BOUNDARY
1/28856637675569152" = 1/230853101404553216" OTHER ONE THIRTY TWO	57" = 57' 6" OTHER ONE EIGHTH	ALM-ALTERNATE LAND SURV.	BN-BOUNDARY
1/57713275351138304" = 1/461706202809106432" OTHER ONE THIRTY TWO	58" = 58' 6" OTHER ONE EIGHTH	ALM-ALTERNATE LAND SURV.	BN-BOUNDARY
1/115426550702276608" = 1/923412405618212864" OTHER ONE THIRTY TWO	59" = 59' 6" OTHER ONE EIGHTH	ALM-ALTERNATE LAND SURV.	BN-BOUNDARY
1/230853101404553216" = 1/1846824811236425728" OTHER ONE THIRTY TWO	60" = 60' 6" OTHER ONE EIGHTH	ALM-ALTERNATE LAND SURV.	BN-BOUNDARY
1/461706202809106432" = 1/3693649622472851456" OTHER ONE THIRTY TWO	61" = 61' 6" OTHER ONE EIGHTH	ALM-ALTERNATE LAND SURV.	BN-BOUNDARY
1/923412405618212864" = 1/7387299244945702912" OTHER ONE THIRTY TWO	62" = 62' 6" OTHER ONE EIGHTH	ALM-ALTERNATE LAND SURV.	BN-BOUNDARY
1/1846824811236425728" = 1/14774598489891405824" OTHER ONE THIRTY TWO	63" = 63' 6" OTHER ONE EIGHTH	ALM-ALTERNATE LAND SURV.	BN-BOUNDARY
1/3693649622472851456" = 1/29549196979782811648" OTHER ONE THIRTY TWO	64" = 64' 6" OTHER ONE EIGHTH	ALM-ALTERNATE LAND SURV.	BN-BOUNDARY
1/7387299244945702912" = 1/59098393959565623296" OTHER ONE THIRTY TWO	65" = 65' 6" OTHER ONE EIGHTH	ALM-ALTERNATE LAND SURV.	BN-BOUNDARY
1/14774598489891405824" = 1/118196787919131246592" OTHER ONE THIRTY TWO	66" = 66' 6" OTHER ONE EIGHTH	ALM-ALTERNATE LAND SURV.	BN-BOUNDARY
1/29549196979782811648" = 1/236393575838262493184" OTHER ONE THIRTY TWO	67" = 67' 6" OTHER ONE EIGHTH	ALM-ALTERNATE LAND SURV.	BN-BOUNDARY
1/59098393959565623296" = 1/472787151676524986368" OTHER ONE THIRTY TWO	68" = 68' 6" OTHER ONE EIGHTH	ALM-ALTERNATE LAND SURV.	BN-BOUNDARY
1/118196787919131246592" = 1/945574303353049972736" OTHER ONE THIRTY TWO	69" = 69' 6" OTHER ONE EIGHTH	ALM-ALTERNATE LAND SURV.	BN-BOUNDARY
1/236393575838262493184" = 1/1891148606706099845472" OTHER ONE THIRTY TWO	70" = 70' 6" OTHER ONE EIGHTH	ALM-ALTERNATE LAND SURV.	BN-BOUNDARY
1/472787151676524986368" = 1/3782297213412199690944" OTHER ONE THIRTY TWO	71" = 71' 6" OTHER ONE EIGHTH	ALM-ALTERNATE LAND SURV.	BN-BOUNDARY
1/945574303353049972736" = 1/7564594426824399381888" OTHER ONE THIRTY TWO	72" = 72' 6" OTHER ONE EIGHTH	ALM-ALTERNATE LAND SURV.	BN-BOUNDARY
1/1891148606706099845472" = 1/15129188453648798763776" OTHER ONE THIRTY TWO	73" = 73' 6" OTHER ONE EIGHTH	ALM-ALTERNATE LAND SURV.	BN-BOUNDARY
1/3782297213412199690944" = 1/30258376907297597527552" OTHER ONE THIRTY TWO	74" = 74' 6" OTHER ONE EIGHTH	ALM-ALTERNATE LAND SURV.	BN-BOUNDARY
1/7564594426824399381888" = 1/60516753814595195055104" OTHER ONE THIRTY TWO	75" = 75' 6" OTHER ONE EIGHTH	ALM-ALTERNATE LAND SURV.	BN-BOUNDARY
1/15129188453648798763776" = 1/121033507629190390110208" OTHER ONE THIRTY TWO	76" = 76' 6" OTHER ONE EIGHTH	ALM-ALTERNATE LAND SURV.	BN-BOUNDARY
1/30258376907297597527552" = 1/242067015258380780220416" OTHER ONE THIRTY TWO	77" = 77' 6" OTHER ONE EIGHTH	ALM-ALTERNATE LAND SURV.	BN-BOUNDARY
1/60516753814595195055104" = 1/484134030516761560440832" OTHER ONE THIRTY TWO	78" = 78' 6" OTHER ONE EIGHTH	ALM-ALTERNATE LAND SURV.	BN-BOUNDARY
1/121033507629190390110208" = 1/968268061033523120881664" OTHER ONE THIRTY TWO	79" = 79' 6" OTHER ONE EIGHTH	ALM-ALTERNATE LAND SURV.	BN-BOUNDARY
1/242067015258380780220416" = 1/193653612206746241763328" OTHER ONE THIRTY TWO	80" = 80' 6" OTHER ONE EIGHTH	ALM-ALTERNATE LAND SURV.	BN-BOUNDARY
1/484134030516761560440832" = 1/387307224413492483526656" OTHER ONE THIRTY TWO	81" = 81' 6" OTHER ONE EIGHTH	ALM-ALTERNATE LAND SURV.	BN-BOUNDARY
1/968268061033523120881664" = 1/774614448826984967053312" OTHER ONE THIRTY TWO	82" = 82' 6" OTHER ONE EIGHTH	ALM-ALTERNATE LAND SURV.	BN-BOUNDARY
1/193653612206746241763328" = 1/1469228897533969934106624" OTHER ONE THIRTY TWO	83" = 83' 6" OTHER ONE EIGHTH	ALM-ALTERNATE LAND SURV.	BN-BOUNDARY
1/387307224413492483526656" = 1/2938457795067939868213248" OTHER ONE THIRTY TWO	84" = 84' 6" OTHER ONE EIGHTH	ALM-ALTERNATE LAND SURV.	BN-BOUNDARY
1/774614448826984967053312" = 1/5876915590135879736426496" OTHER ONE THIRTY TWO	85" = 85' 6" OTHER ONE EIGHTH	ALM-ALTERNATE LAND SURV.	BN-BOUNDARY
1/1469228897533969934106624" = 1/11753831180271759472852992" OTHER ONE THIRTY TWO	86" = 86' 6" OTHER ONE EIGHTH	ALM-ALTERNATE LAND SURV.	BN-BOUNDARY
1/2938457795067939868213248" = 1/23507662360543518945705984" OTHER ONE THIRTY TWO	87" = 87' 6" OTHER ONE EIGHTH	ALM-ALTERNATE LAND SURV.	BN-BOUNDARY
1/5876915590135879736426496" = 1/47015324721087037891411968" OTHER ONE THIRTY TWO	88" = 88' 6" OTHER ONE EIGHTH	ALM-ALTERNATE LAND SURV.	BN-BOUNDARY
1/11753831180271759472852992" = 1/94030649442174075782823936" OTHER ONE THIRTY TWO	89" = 89' 6" OTHER ONE EIGHTH	ALM-ALTERNATE LAND SURV.	BN-BOUNDARY
1/23507662360543518945705984" = 1/188061288844348148965647872" OTHER ONE THIRTY TWO	90" = 90' 6" OTHER ONE EIGHTH	ALM-ALTERNATE LAND SURV.	BN-BOUNDARY
1/47015324721087037891411968" = 1/376122577688696297931295744" OTHER ONE THIRTY TWO	91" = 91' 6" OTHER ONE EIGHTH	ALM-ALTERNATE LAND SURV.	BN-BOUNDARY
1/94030649442174075782823936" = 1/752245155377392595862591488" OTHER ONE THIRTY TWO	92" = 92' 6" OTHER ONE EIGHTH	ALM-ALTERNATE LAND SURV.	BN-BOUNDARY
1/188061288844348148965647872" = 1/1504490310754785977325182976" OTHER ONE THIRTY TWO	93" = 93' 6" OTHER ONE EIGHTH	ALM-ALTERNATE LAND SURV.	BN-BOUNDARY
1/376122577688696297931295744" = 1/3008980621509571954650365952" OTHER ONE THIRTY TWO	94" = 94' 6" OTHER ONE EIGHTH	ALM-ALTERNATE LAND SURV.	BN-BOUNDARY
1/752245155377392595862591488" = 1/6017961243019143909300711904" OTHER ONE THIRTY TWO	95" = 95' 6" OTHER ONE EIGHTH	ALM-ALTERNATE LAND SURV.	BN-BOUNDARY
1/1504490310754785977325182976" = 1/12035924486038287818601423808" OTHER ONE THIRTY TWO	96" = 96' 6" OTHER ONE EIGHTH	ALM-ALTERNATE LAND SURV.	BN-BOUNDARY
1/3008980621509571954650365952" = 1/24071848972076575637202847616" OTHER ONE THIRTY TWO	97" = 97' 6" OTHER ONE EIGHTH	ALM-ALTERNATE LAND SURV.	BN-BOUNDARY
1/6017961243019143909300711904" = 1/48143697944153151274405695232" OTHER ONE THIRTY TWO	98" = 98' 6" OTHER ONE EIGHTH	ALM-ALTERNATE LAND SURV.	BN-BOUNDARY
1/12035924486038287818601423808" = 1/96287395888306302548801138464" OTHER ONE THIRTY TWO	99" = 99' 6" OTHER ONE EIGHTH	ALM-ALTERNATE LAND SURV.	BN-BOUNDARY
1/24071848972076575637202847616" = 1/19247479176163151274405695232" OTHER ONE THIRTY TWO	100" = 100' 6" OTHER ONE EIGHTH	ALM-ALTERNATE LAND SURV.	BN-BOUNDARY

GENERAL NOTES:

- LEGAL DESCRIPTION PROVIDED BY OTHERS
- THE LANDS SHOWN HEREON WERE NOT ABSTRACTED FOR EASEMENTS OR OTHER RECORDED ENCUMBRANCES NOT SHOWN ON THE PLAN.
- UNDERGROUND PORTIONS OF FOOTINGS, FOUNDATIONS OR OTHER IMPROVEMENTS WERE NOT LOCATED.
- ALL TIES ARE TO THE FACE OF THE WALL AND ARE NOT TO BE USED TO PRODUCE A RIGHT-ANGULAR CORNER.
- NOT VALID WITHOUT THE SIGNATURE & ORIGINAL RAISED SEAL OF A LICENSED SURVEYOR AND MAPPER.
- ONE TIEABLE ENCUMBRANCE IS LOCATED.
- NO IDENTIFICATION FOUND ON PROPERTY CORNERS UNLESS NOTED.
- ENCUMBRANCES SHOWN ARE IN AT AND MEASURED UNLESS OTHERWISE SHOWN.
- FENCE OWNERSHIP NOT DETERMINED.
- ELEVATIONS IF SHOWN ARE BASED UPON M.G.V.D. UNLESS OTHERWISE NOTED.
- BEARINGS REFERENCED TO LINE NOTED AS B.R.
- THIS SURVEY DEPICTED HERE FORMS A CLOSED GEOMETRIC FIGURE.
- NO UNDERGROUND IMPROVEMENTS OR VISIBLE INSTALLATIONS HAVE BEEN LOCATED OTHER THAN SHOWN.

I HEREBY CERTIFY THAT THIS TOPOGRAPHIC SURVEY IS A TRUE AND CORRECT REPRESENTATION OF A SURVEY PREPARED UNDER MY DIRECTION.

SIGNED: R.L. Roberts STATE OF FLORIDA
 R.L. ROBERTS LAND SURVEYOR & MAPPER NO. 3144

SIGNED: DAVE MICHAEL SMITH STATE OF FLORIDA
 DAVE MICHAEL SMITH LAND SURVEYOR & MAPPER NO. 3702

SIGNED: LOUIS R. RAMBLE STATE OF FLORIDA
 LOUIS R. RAMBLE LAND SURVEYOR & MAPPER NO. 6304

THE SPECIFIC PURPOSE OF THIS TOPOGRAPHIC SURVEY IS TO DEPICT SELECTED STRUCTURES AND ELEVATIONS AS REQUESTED BY CLIENT.

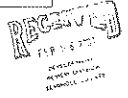
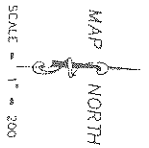
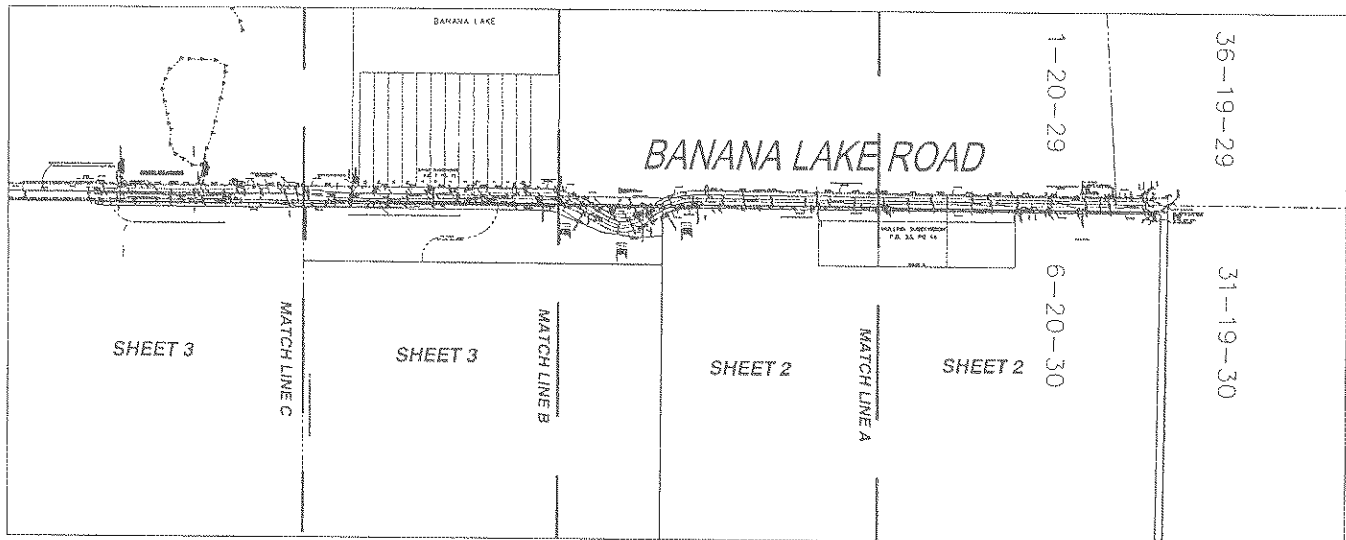

THIS SURVEY IS NOT VALID UNLESS EMBOSSED WITH THE SIGNING SURVEYOR'S RAISED SEAL.

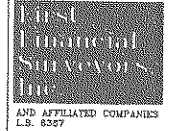

198 South Orange
 Orange, Florida 32708
 (407) 977-7927 Fax (407) 977-7928

SPECIFIC PURPOSE TOPOGRAPHIC SURVEY

THIS IS NOT A BOUNDARY SURVEY

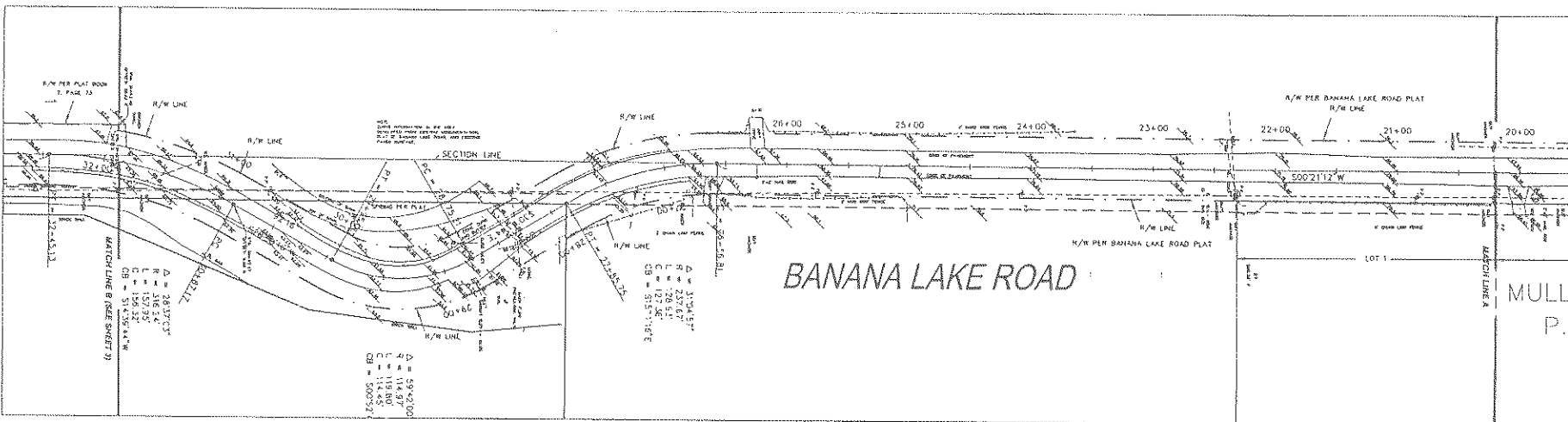
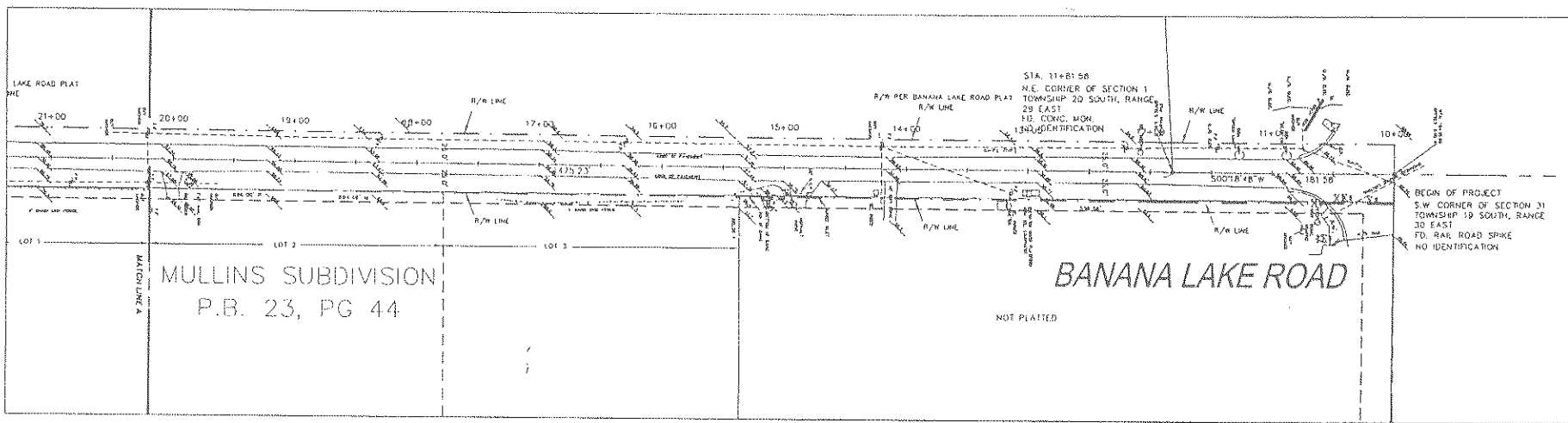

SCALE = 1" = 40'

MAP NORTH

THIS SURVEY IS NOT VALID UNLESS EMPLOYED WITH THE SIGNING SURVEYOR'S RAISED SEAL.

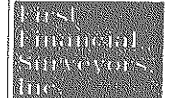

600 John Avenue
 Quincy, Florida 32210
 (904) 877-7100 Fax (904) 877-7000

SPECIFIC PURPOSE TOPOGRAPHIC SURVEY

THIS IS NOT A BOUNDARY SURVEY

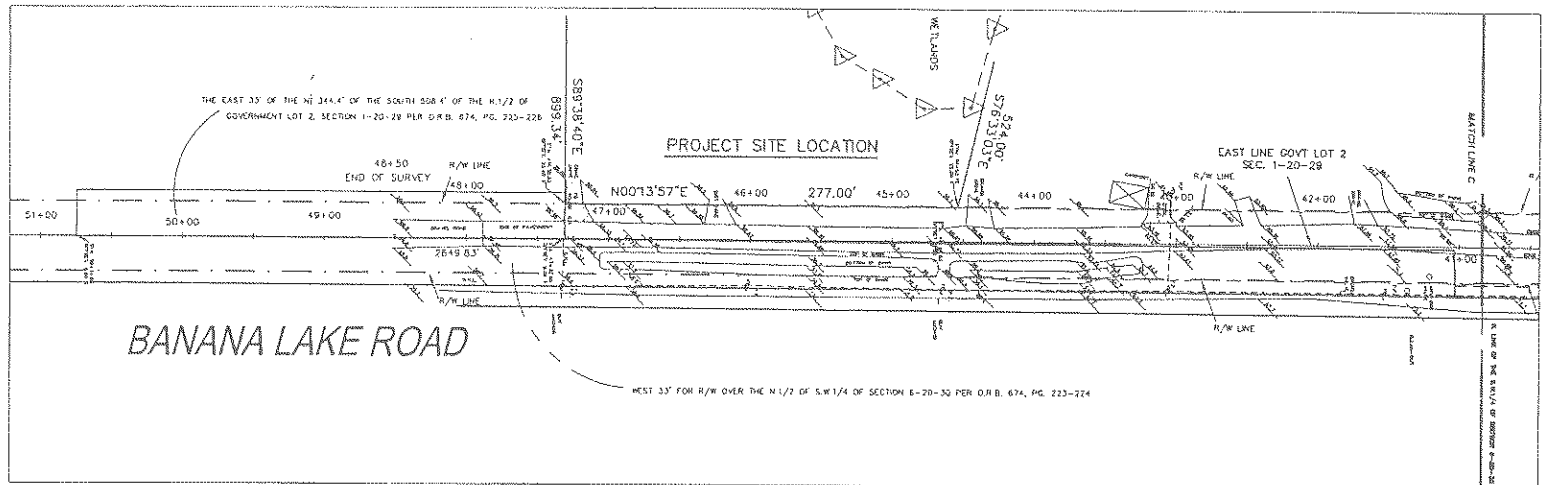
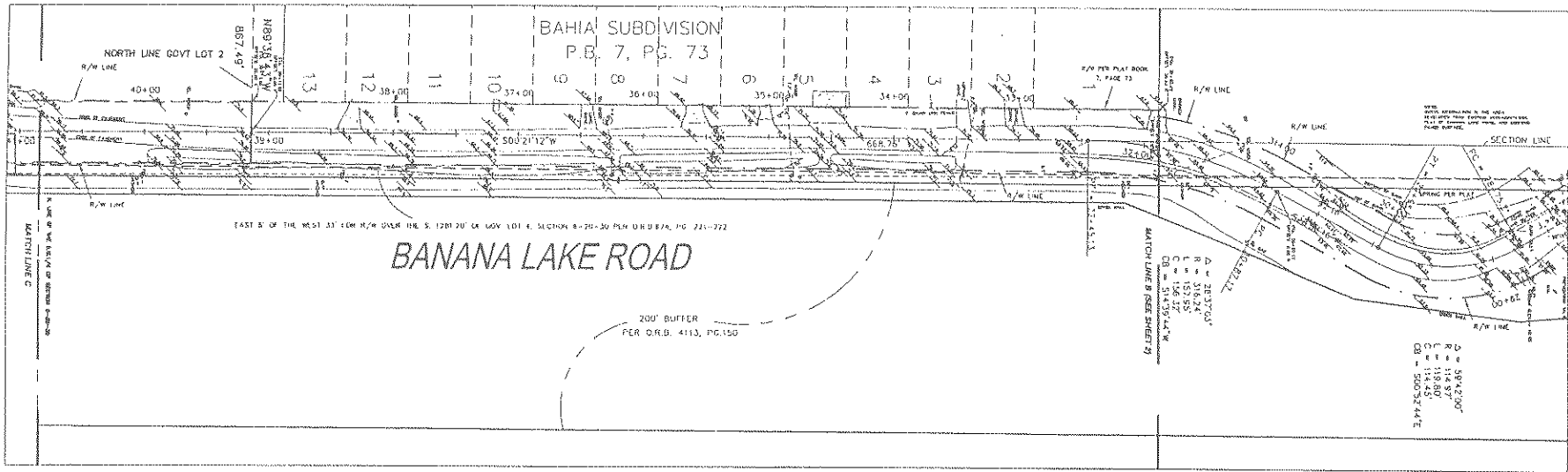

SCALE 1" = 40'

MAP NORTH

SHEET 3 OF 3

THIS SURVEY IS NOT VALID UNLESS EMBOSSED WITH THE SIGNING SURVEYOR'S RAISED SEAL.

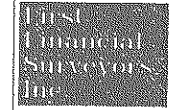

805 South Broadway
Chicago, Illinois 60607
(603) 875-7450 Fax (603) 875-7099

AND AFFILIATED COMPANIES
L.B. 6357

REGISTRATION 1-800-797-3486 Fax 1-800-797-3486

\\p01\proj\200303\449\18101.dwg 02/05/2003 02:48:15 PM PK EST



BANANA LAKE ROAD



RECEIVED
 FEB 06 2003
 DEVELOPMENT
 TRAFFIC SECTION
 ENGINEERING DIVISION

ENGINEERING & ENVIRONMENTAL DESIGN, INC. PROFESSIONAL ENGINEERS AND ARCHITECTS 12101 W. BAYVIEW BLVD., SUITE 200 MIAMI, FL 33147 (305) 556-8800 FAX (305) 556-8801	
BANANA LAKE ROAD BANANA LAKE VILLAS	
PROJECT NO. DRAWING NO. SHEET NO.	DATE DESIGNER CHECKER IN CHARGE
3 1 3	02/05/03 [Signature] [Signature]

H:\proj\20623\dwg\N18E3.dwg 02/05/2003 02:46:27 PM PM EST

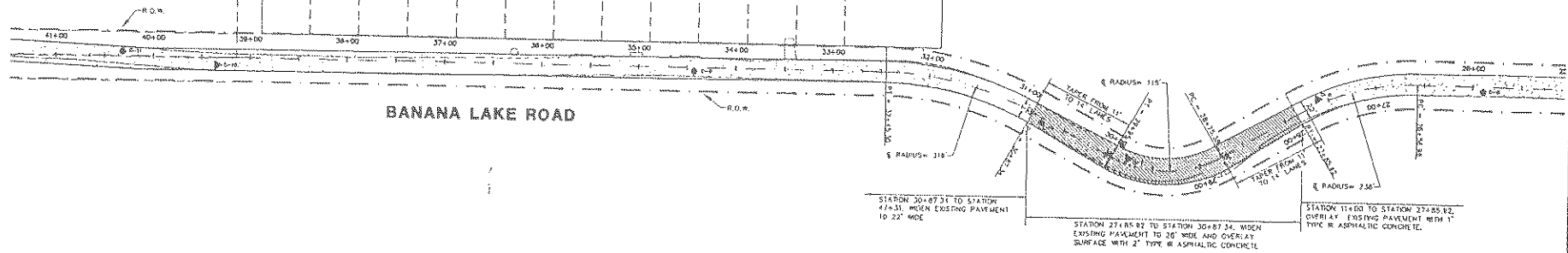
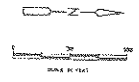
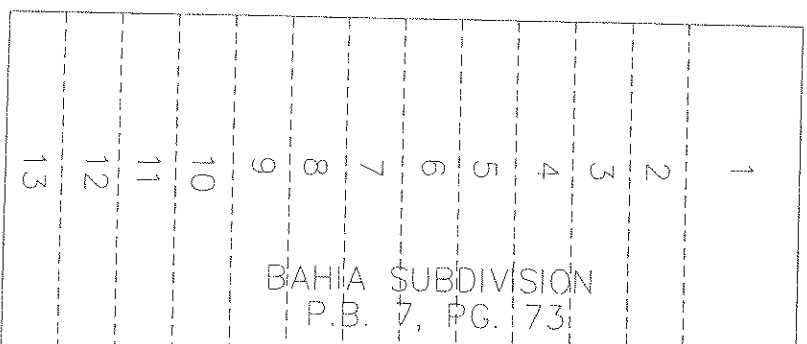

BANANA LAKE ROAD

BAHIA SUBDIVISION
P.B. 7, PG. 73

STATION 30+87.31 TO STATION
4+31.1 WHEN EXISTING PAVEMENT
IS 22' WIDE

STATION 27+88.82 TO STATION 30+87.34. WHEN
EXISTING PAVEMENT IS 30' WIDE AND OVERLAY
SURFACE WITH 2" TYPE II ASPHALTIC CONCRETE.

STATION 11+00 TO STATION 27+25.82.
OVERLAY EXISTING PAVEMENT WITH 1"
TYPE II ASPHALTIC CONCRETE.

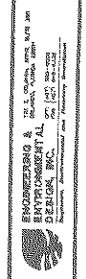

BANANA LAKE ROAD
BANANA LAKE VILLAS

NO.	DATE	BY	CHKD.
1	02/05/03
2			
3			

*Minutes for the Seminole County
LPA/P&Z Board*

*WEDNESDAY, FEBRUARY 19, 2003
7:00 P.M.*

Members present: Alan Peltz, Dick Harris, Chris Dorworth, Thomas Mahoney, Ben Tucker, Beth Hattaway, and Dudley Bates

Also present: Matt West, Planning Manager, Mahmoud Najda, Development Review Manager, Kent Cichon, Financial Manager, Jeff Hopper, Senior Planner, Rob Walsh, Principal Coordinator, Cynthia Sweet, Planner, Candace Lindlaw-Hudson, Sr. Staff Assistant.

Members present: Alan Peltz, Dick Harris, Chris Dorworth, Thomas Mahoney, Ben Tucker, Beth Hattaway, and Dudley Bates

Also present: Matt West, Planning Manager, Mahmoud Najda, Development Review Manager, Kent Cichon, Financial Manager, Jeff Hopper, Senior Planner, Rob Walsh, Principal Coordinator, Cynthia Sweet, Planner, Candace Lindlaw-Hudson, Sr. Staff Assistant.

Banana Lake PD; James H. Fant, applicant; approximately 25.05 acres; Large Scale Plan Amendment from Suburban Estates to Planned Development; 02S.FIU04; Rezone from A-1 (Agriculture) to PUD (Planned Unit Development); west of Banana Lake Road, approximately 3,400 feet south of CR-46A (Z2001-044)
Commissioner McLain - District 5
Kent Cichon, Financial Manager

Kent Cichon outlined the main points of the request and stated that there had been two public meetings on this issue with Staff this past month. The applicant is requesting to develop up to 43 lots at a net density of 6.05 dwelling units per acre. He noted that the conceptual site plan reflects this formula, but the staff report contains a previously used figure of 5.7 dwelling units per acre. Future Land Use designation for the subject property is suburban estates. Access to the site will be from Banana Lake Road on the east, which the developer will improve to County standards. Mr. Cichon stated that Staff recommendation was for transmittal of the development order, but does not recommend adoption until the applicant demonstrates the existence of sufficient right of way to improve the length of Banana Lake Road to County standards. Mr. Cichon said that the applicant had held two public meetings during the past month which were attended by County staff.

Commissioner Tucker asked if the right of way issues involved a third party. Mr. Cichon stated that there was a third party involved with the right of way.

Commissioner Tucker pointed out that Mr. Cichon was making a recommendation contingent on a third party involvement.

Larry Ray of 3347 Edge Cliff Drive, Orlando, representing the owner, stated that there were issues with the right of way. Plats were not clear on the right of way. In the next 90 days he will conduct a title search to research the right of way prior to going to the BCC. He introduced a letter from Colonial Properties, the property owner to the south and the east which states that they approve of the request.

Mr. Ray stated that there are 7 things that the owners have agreed to do in addition to the development order, once the property has been rezoned.

- 1) All boat access to Island Lake will be restricted to the adjacent future property owners. A common gazebo will be permitted on the lake.
- 2) No gas motors will be allowed on Island Lake.
- 3) A private wall will be built between the Heathrow property and the Edwards property. (property to the north)
- 4) Only single story homes will be allowed to be built on the lakeside line near Heathrow.
- 5) A privacy wall will be built between the wetlands and the lake along the property line between Mr. Springfield's property and Edward's property. This wall will separate the Edward's property from the subdivision.
- 6) Lake access to Banana Lake will be restricted to adjacent property owners to the lake.
- 7) No motor boats will be allowed on Banana Lake.

No one else spoke in favor of the request.

Mr. Sims spoke for the Homeowner's Advisory Board for Heathrow. Mr. Sims was representing 80 homes between Island Lake and Banana Lake. He stated that the area on the isthmus was zoned for a rural setting. If the applicant meets the tests to get the request granted Mr. Sims asked that the privacy wall be a brick wall of at least 8 feet in height. Further, Mr. Sims requested that the buffer of 50 feet be kept as a natural, vegetative buffer. The reason for this was the presence of wildlife. The retention pond will destroy the character of the neighborhood. It will cause flooding. We are opposed to the retention pond. If the proposal is amended to have a natural, vegetative buffer and 8 foot privacy wall, the objections would be significantly reduced.

Wendell Springfield of 770 Banana Lake Road, north of the proposed project said that he agrees with the wall proposed. His lot is 360 feet deep. He stated that his land is approximately 10 feet lower than the subject property. He is concerned about drainage and overflow coming from the lots and proposed buildings. The number of proposed houses (43) is too large. 25 houses would be more in line with the transition between Colonial Apartments and Heathrow Complex. He is zoned suburban estates/A-1 Agriculture. He has a concern for the congestion that 43 homes will cause on Banana Lake Road. Mr. Springfield requested that the number of houses be limited to 25. There is a wetland on the property which has been a retention area. He would like to see a culvert to carry water from Banana Lake to Island Lake. In conclusion Mr. Springfield stated that the area has been a haven for wild life and a key recharge area through the wetlands. He would like to see a 100 foot buffer provided from the water. Also, Banana Lake Road will not stand up to any more traffic. He would like to see this project postponed until the Board can see what is being done with Banana Lake Road.

Janice Real Springfield stated she has owned land on Banana Lake for 40 years. Banana Lake is 41 acres, and her house is 10 feet from the lake. When Heathrow was approved the County agreed that access to Banana Lake was to be kept to one acre per house. She requested the buffer continue to

the Edwards property to the south. She also would like the number of houses to be limited to 25 houses. She also stated that sidewalks are needed on the east side of the road. Ms. Springfield also noted that there had been flooding in the area and pointed out the importance of the culvert which feeds into Banana Lake.

Mark Brewer of 800 Banana Lake Road stated that he lives next to Wendall Springfield. Mr. Brewer said that there is supposed to be a 100 foot buffer around the lake. He stated that 43 homes are too many. He thought 25 homes were also too many for the area allotted. Another concern for Mr. Brewer was access to Banana Lake Road. His lot had also been flooded recently.

Tyrone Wilson of 910 Banana Lake Road has owned his home for 2 months. He has a sinkhole on his property. He was concerned about flooding. Would the change in drainage bring waters to the sinkhole on his property. His septic system has been unusable due to water. He would like to see a consistent 100 foot setback. Mr. Wilson asked where the water draining off the road would go.

Elisa McIntosh of 864 Banana Lake Road stated that 43 homes would not be in keeping with the character of the rest of the neighborhood. She lives on a house that is close to the road and must back her car out onto Banana Lake Road. Safety was an issue to her, with the rural character to the road as it is now. Vibrations from the road can be felt in her home.

Lynn Shields of 552 Lakeworth Circle is a member of the Town Advisory Committee in Heathrow. She stated that the greenbelt/wetland area should be preserved for already existing homes and the Heathrow neighbors. She requested that if the property is rezoned it should include only single story homes. Also, a buffer of natural vegetation should be included within the plan and an 8 foot security wall. On the lake there should be a restriction on boat size and motors. Ms. Shields would also like this to be a gate restricted community.

Janice Farrell of 874 Banana Lake Road said that a gazebo on the lakefront would be a problem. She lives on the west side of the lake, below the grade of the road. There is a grade that slopes toward the lake. Water in the sinkhole is very high. If Banana Lake Road is to be widened, her drainage field is near the road. She has no other place on her property for her septic field. Also, she must back out onto the road as does her neighbor. She is concerned about traffic and congestion as well as road widening. Ms. Farrell asked that the 100 foot buffer be kept around the lake. Also, she has a stability problem with the sinkhole nearby. The density of the proposed development should be kept to 25.

Cindy Crane of 820 Banana Lake Road, Lake Mary, has lived in her home since 1963. The sinkhole near the road is on her property. She asked to have a density of 25 homes. This needs to be a secure, high quality project, limited to one story homes. An exit road on the east through HIBC to the business center driveway is a good alternate way to access this development which would eliminate the use of Banana Lake Road. Ms. Crane would like to see a brick wall on the north and south boundaries of the Edwards property.

Larry Ray spoke in rebuttal saying that his project is avoiding the wetlands. He is meeting all of the state and county requirements for drainage and protecting endangered species. He will deal with St. John's River Water Management District regulations. There has been an engineering analysis done on the road and they will work with Development Review. Widening will be on the east side of the road. Buffers with Heathrow will be 50 feet, which may be used for retention. They will not flood the

Springfield home. As for density, we will have higher density on the south side and higher density to the north. A lot of issues need to be answered at the next step. Now he is concerned about adequate right of way.

Commissioner Mahoney read Dianne Kramer's memo into the record concerning the potential population and impact on area schools and this development.

Commissioner Harris stated that the area residents have been accommodating to this project. He cannot find a single element which is attractive. A retention pond is incompatible; and a great deal of work is required to make the isthmus livable. There are drainage problems with this development. The development of Colonial Grand needed a 200 foot buffer to Mr. Edward's property.

**Commissioner Harris made a motion to deny this request.
Commissioner Mahoney seconded the motion.**

Commissioner Mahoney stated that this is a change in land use plan. There has not been enough discussion of the change to the character. 43 homes on 50 by 100 foot lots will give easily 400 trips on Banana Lake Road, which is incompatible with the lifestyle of the people in the area. Heathrow International Business Center has significant buffers to adjacent residential areas. We must preserve the current environment.

Commissioner Hattaway stated that the area is a fragile one.

Commissioner Bates concurred with the previous comments.

Commissioner Tucker agreed also. He stated that he was concerned about this matter being brought forth without the right of way issues being determined.

The vote was 7 – 0 to deny the request.